

NK-300E-v

FULLY HYDRAULIC TRUCK CRANE

SPECIFICATION

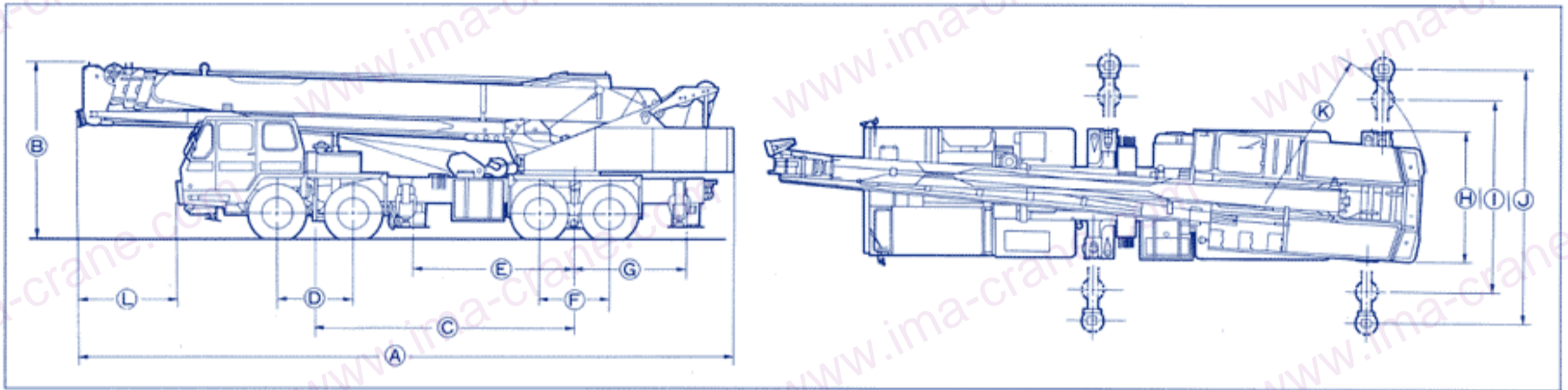

Carrier name and model	A	B	C	D	E	F	G	H	I	J	K	L
Mitsubishi K303LA	12,580	3,450	5,000	1,450	3,100	1,350	2,150	2,500	4,100	6,100	3,395	1,800
Nissan Diesel KG45SXL	12,580	3,450	4,940	1,520	3,100	1,300	2,100	2,500	4,100	6,100	3,395	1,630

(Unit : mm)

CRANE SPECIFICATION

Performance

Maximum rated lifting capacity	: 30 metric tons × 3.0m
Boom length	: 10.5m ~ 33m (4 section)
Fly jib length	: 8.7m ~ 14.5m (2 section)
Max. lifting height	: 32.8 m (Boom) 47.3 m (33 m Boom + 14.5 m jib offset 5°)
Boom derricking angle	: -3° ~ 80°
Boom derricking time	: 53 sec. (-3° ~ 80°)
Boom extending time	: 110 sec. (10.5m ~ 33m)
Hoisting line speed	
Main winch	: 110m/min. (at 4th layer)
Auxiliary winch	: 95m/min. (at 2nd layer)
Hoisting hook speed	
Main winch (part of line; 10)	: 11.0m/min. (at 4th layer)
Auxiliary winch (part of line; 1)	: 95.0m/min. (at 2nd layer)
Slewing speed	: 2.6 r.p.m. (Speed: Subject to no load)

Hoisting Ropes

Main winch;	Type	: 4 × F (a + 40) (Non-rotating type)
	Diameter	: 16mm
	Length	: 180m
Auxiliary winch;	Type	: 4 × F (a + 40) (Non-rotating type)
	Diameter	: 16mm
	Length	: 105m

Hydraulic System

Oil pump	: 4 section gear type
Hoisting motor	: Axial plunger type
Slewing motor	: Axial plunger type
Cylinder	: Double acting type
Control valve	: 3 position 4 way double acting with integral check and relief valves
Oil reservoir capacity	: 420 lit.

Superstructure

Hoisting mechanism	: Hydraulic motor-driven, gear reduction type (automatic brake system) single winch x 2
Slewing mechanism	: Ball bearing type
Boom derricking mechanism	: Direct-acting cylinder type
Outrigger system	: Hydraulic, vertically supporting with float and vertical cylinder in single unit
Front jack (option)	: Hydraulic, vertically supporting with float and vertical cylinder in single unit
Crane cab	: All steel welded construction

Winch system

Main winch & Auxiliary winch	: Driven by axial plunger type hoisting motor through built-in gear reduction. Controlled independently by respective operating lever. Equipped with automatic brake. With free fall device
------------------------------	---

Safety Devices

Microcomputer type ACS fully automatic overload protection device (Moment Limiter)
 Boom falling safety device, Overhoist prevention device, Drum lock device, Automatic winch brake, Irregular winding prevention device, Hydraulic safety valve, Outrigger lock device, Slewing lock device

Option

Oil cooler, Front jack, Voice alarm device for ACS, Heater, fan and radio for crane cabin

شرکت ایمن مرکزی اروند (سهامی خاص)

نماینده رسمی فروش و خدمات پس از فروش
 جرثقیل های کاتو و هیبتاچی سومیتومو در ایران

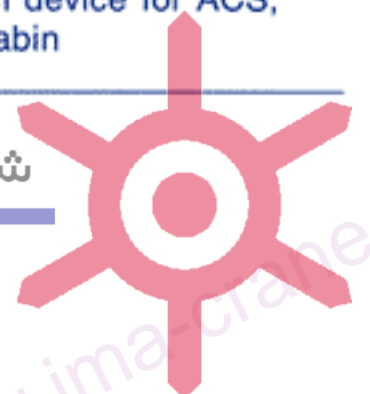

RATED LIFTING CAPACITY

Based on BS 1757 : 1986
DIN 15019-2
75% of tipping loads

Note: Front jack is optional.

Outriggers fully extended with front jack – 360° full range Outriggers fully extended without front jack – over side and over rear								Outriggers intermediately extended without front jack – 360° full range Outriggers fully extended without front jack – over front							
Working radius (m)	10.5 m Boom	14.2 m Boom	18 m Boom	21.7 m Boom	25.5 m Boom	29.2 m Boom	33 m Boom	Working radius (m)	10.5 m Boom	14.2 m Boom	18 m Boom	21.7 m Boom	25.5 m Boom	29.2 m Boom	33m Boom
2.5	30.00	20.00	16.00					2.5	25.00	20.00	16.00				
3.0	30.00	20.00	16.00					3.0	25.00	20.00	16.00				
3.5	25.40	20.00	16.00	12.00				3.5	25.00	20.00	16.00	12.00			
4.0	22.90	20.00	16.00	12.00	11.50			4.0	22.90	20.00	16.00	12.00	11.50		
4.5	21.00	20.00	16.00	12.00	11.50			4.5	17.35	16.20	16.00	12.00	11.50		
5.0	19.40	18.40	16.00	12.00	11.50	9.00		5.0	14.00	13.60	13.45	12.00	11.50	9.00	
6.0	16.20	15.30	13.70	12.00	11.50	9.00	7.00	5.5	11.60	11.40	11.20	12.00	11.50	9.00	
7.0	13.70	12.65	11.95	11.00	10.00	9.00	7.00	6.0	10.00	9.80	9.60	10.20	10.10	9.00	7.00
8.0	11.15	10.65	10.55	10.20	8.90	8.20	7.00	6.5	8.50	8.50	8.15	8.95	9.10	9.00	7.00
8.5	10.25	9.70	9.65	9.65	8.45	7.80	6.60	7.0	7.55	7.25	7.15	7.80	8.10	8.30	7.00
9.0		8.80	8.80	9.20	8.05	7.45	6.25	7.5	6.50	6.40	6.20	6.85	7.25	7.35	7.00
10.0		7.30	7.15	7.65	7.30	6.75	5.70	8.5	5.00	4.95	4.85	5.40	5.75	5.85	5.80
12.0		5.10	4.95	5.40	5.65	5.65	4.80	9.0		4.35	4.30	4.80	5.10	5.25	5.30
12.5		4.70	4.55	5.05	5.25	5.45	4.55	10.0		3.45	3.35	3.85	4.10	4.30	4.40
13.0			4.20	4.65	4.90	5.05	4.45	12.0		2.10	1.95	2.45	2.70	2.90	3.05
14.0			3.55	4.00	4.25	4.40	4.10	12.5		1.70	1.70	2.15	2.40	2.65	2.80
16.0			2.55	2.95	3.20	3.40	3.50	13.0			1.40	1.90	2.15	2.40	2.55
18.0				2.20	2.45	2.65	2.80	14.0			0.95	1.40	1.70	1.95	2.10
20.0				1.65	1.85	2.05	2.20	15.0			0.55	1.05	1.30	1.55	1.75
22.0					1.40	1.60	1.70	16.0				0.70	1.00	1.20	1.40
24.0						1.20	1.35	17.0				0.40	0.70	0.95	1.10
26.0						0.90	1.00	18.0					0.45	0.70	0.85
27.5						0.70	0.85	19.0						0.45	0.60
29.0							0.65	20.0							0.40
31.0							0.45								
Standard hook	for 30 ton							Standard hook	for 30 ton						
Hook weight	300 kg							Hook weight	300 kg						
Parts line	10	8			4			Parts line	10	8			4		
Critical boom angle	—	—	—	—	—	—	—	Critical boom angle	—	—	—	25°	35°	42°	47°

(Unit: Metric ton)

(Unit: Metric ton)

Outriggers fully extended with front jack – 360° full range Outriggers fully extended without front jack – over side and over rear						
Boom angle (°)	33 m Boom + 8.7 m Jib					
	Offset 5°		Offset 17°		Offset 30°	
	Working radius (m)	Load (t)	Working radius (m)	Load (t)	Working radius (m)	Load (t)
80.0	8.0	3.00	9.6	2.20	11.3	1.60
76.0	11.0	3.00	12.5	2.20	14.0	1.60
74.0	12.5	2.72	14.0	2.05	15.3	1.54
70.0	15.3	2.26	16.6	1.78	18.0	1.45
66.0	18.0	1.92	19.2	1.57	20.4	1.30
62.0	20.5	1.68	21.8	1.38	22.8	1.17
58.0	23.0	1.48	24.1	1.24	25.0	1.06
56.0	24.0	1.28	25.2	1.18	26.0	1.02
54.0	25.1	1.08	26.3	1.00	27.1	0.98
50.0	27.2	0.74	28.2	0.70	29.0	0.67
46.0	29.2	0.47	30.1	0.44	30.7	0.43
43.0	30.6	0.30	31.5	0.30	32.0	0.30
Standard hook	for 3 ton					
Hook weight	60 kg					
Parts line	1					
Critical boom angle	40°					

(Unit: Metric ton)

Outriggers fully extended with front jack – 360° full range Outriggers fully extended without front jack – over side and over rear						
Boom angle (°)	33 m Boom + 14.5 m Jib					
	Offset 5°		Offset 17°		Offset 30°	
	Working radius (m)	Load (t)	Working radius (m)	Load (t)	Working radius (m)	Load (t)
80.0	9.9	2.00	12.5	1.30	15.1	0.90
77.7	12.0	2.00	14.5	1.30	16.9	0.90
76.3	13.2	1.85	15.7	1.24	18.0	0.90
72.0	16.4	1.50	19.0	1.06	21.2	0.81
68.0	19.5	1.25	22.0	0.91	24.0	0.74
64.0	22.6	1.06	24.8	0.79	26.6	0.67
60.0	25.4	0.90	27.4	0.70	29.1	0.60
56.0	28.0	0.77	29.9	0.64	31.5	0.55
52.0	30.7	0.66	32.4	0.57	33.7	0.52
51.0	31.2	0.61	33.0	0.55	34.2	0.51
50.4	31.6	0.57	33.3	0.52	34.5	0.50
48.0	32.9	0.45	34.5	0.40	35.6	0.38
46.0	33.9	0.35	35.2	0.33	36.5	0.30
Standard hook	for 3 ton					
Hook weight	60 kg					
Parts line	1					
Critical boom angle	42°					

شرکت ایمن مرکزی اروند
نماینده رسمی فروش و خدمات پس از فروش
جرثقیل های کاتو و هیلتاچی سومیتومو در ایران

(Unit: Metric ton)

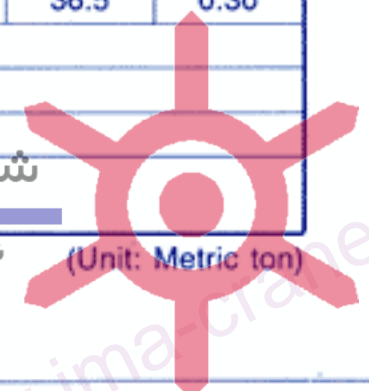

Outriggers intermediately extended without front jack – 360° full range Outriggers fully extended without front jack – over front						
Boom angle (°)	33 m Boom + 8.7 m Jib					
	Offset 5°		Offset 17°		Offset 30°	
	Working radius (m)	Load (t)	Working radius (m)	Load (t)	Working radius (m)	Load (t)
80.0	8.0	3.00	9.6	2.20	11.3	1.60
76.0	11.0	3.00	12.5	2.20	14.0	1.60
72.5	13.5	2.56	15.0	1.94	16.2	1.50
71.0	14.5	2.14	16.0	1.84	17.3	1.47
70.0	15.1	1.90	16.6	1.65	18.0	1.45
68.0	16.3	1.48	17.8	1.28	19.0	1.18
65.0	18.1	0.97	19.5	0.86	20.7	0.78
60.0	21.0	0.37	22.4	0.30	23.3	0.30
Standard hook	for 3 ton					
Hook weight	60 kg					
Parts line	1					
Critical boom angle	58°					

(Unit: Metric ton)

Outriggers intermediately extended without front jack – 360° full range Outriggers fully extended without front jack – over front						
Boom angle (°)	33 m Boom + 14.5 m Jib					
	Offset 5°		Offset 17°		Offset 30°	
	Working radius (m)	Load (t)	Working radius (m)	Load (t)	Working radius (m)	Load (t)
80.0	9.9	2.00	12.5	1.30	15.1	0.90
77.7	12.0	2.00	14.5	1.30	16.9	0.90
76.3	13.2	1.85	15.7	1.24	18.0	0.90
73.0	15.6	1.57	18.2	1.10	20.4	0.84
69.0	18.7	1.31	21.2	0.95	23.3	0.76
68.4	19.1	1.18	21.7	0.92	23.8	0.75
67.8	19.5	1.08	22.0	0.88	24.2	0.73
64.0	22.0	0.60	24.4	0.49	26.4	0.43
62.0	23.4	0.39	25.6	0.33	27.5	0.30
Standard hook	for 3 ton					
Hook weight	60 kg					
Parts line	1					
Critical boom angle	60°					

(Unit: Metric ton)

NOTES:

- (1) The rated lifting capacities are the maximum loads guaranteed on a firm level ground and include the weight of hook block and other lifting equipment. The capacities enclosed with bold lines are based on the structural strength of machine and the others are based on the stability of machine.
- (2) The working radii as given in the table are the actual values including the deflection of the boom. Therefore, operate the machine based on the working radius. However, the working radii shown for jib operations are based on the values obtained when the boom is fully extended (33 m). Jib operations should be performed on the basis of boom angle only, regardless of boom length when the boom is not fully extended.
- (3) The rated lifting capacities for the rooster sheave are equivalent to the rated lifting capacities for the main boom to a maximum of 3000 kg. At all times the weight of all lifting equipment in use (including main hook block suspended from boom head) forms part of load and must be subtracted from the rated lifting capacity.
- (4) If the boom length exceeds the specified value, the rated lifting capacities for the boom length above and below the present boom length should be referred to, and the crane should be operated within the smaller lifting capacity.
- (5) When using the main boom with the jib installed, 1800 kg plus the weight of hook block and other lifting equipment, etc., should be subtracted from the rated lifting capacities. When performing the above operation, do not use the rooster sheave.
- (6) The standard number of parts of line is shown in the rated lifting capacity table. When the standard number of parts of line is not used, the minimum number of parts of line is determined so that weight per part will not exceed 3000 kg.
- (7) Without front jack, over front lifting performance is inferior to over side and over rear lifting performance. Great care should be taken when transferring from over side to over front since there is a danger of overloading.
- (8) Critical boom angles for each boom length are shown on bottommost line of lifting capacity table. If the boom angle is lowered to less than the critical boom angle, the machine will tip over without load. Therefore, never lower the boom below these angles.
- (9) Free fall is adopted in principle to lower the hook only. If it is necessary to lower a load by free fall, its weight should be less than 20% of the rated lifting capacity and abrupt braking should not be allowed.
- (10) The machine will tip over or be damaged if operated with a load exceeding that specified in the rated lifting capacity table or not conforming to correct handling. If such trouble occurs, the machine will not be warranted.

شرکت ایمن مرکزی اروند (سهامی خاص)

نماینده رسمی فروش و خدمات پس از فروش
جرثقیل های کاتو و هیبتاچی سومیتومو در ایران

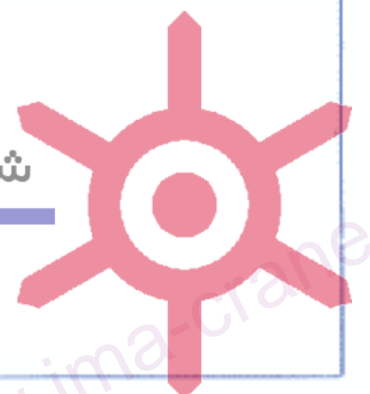

WORKING RANGE

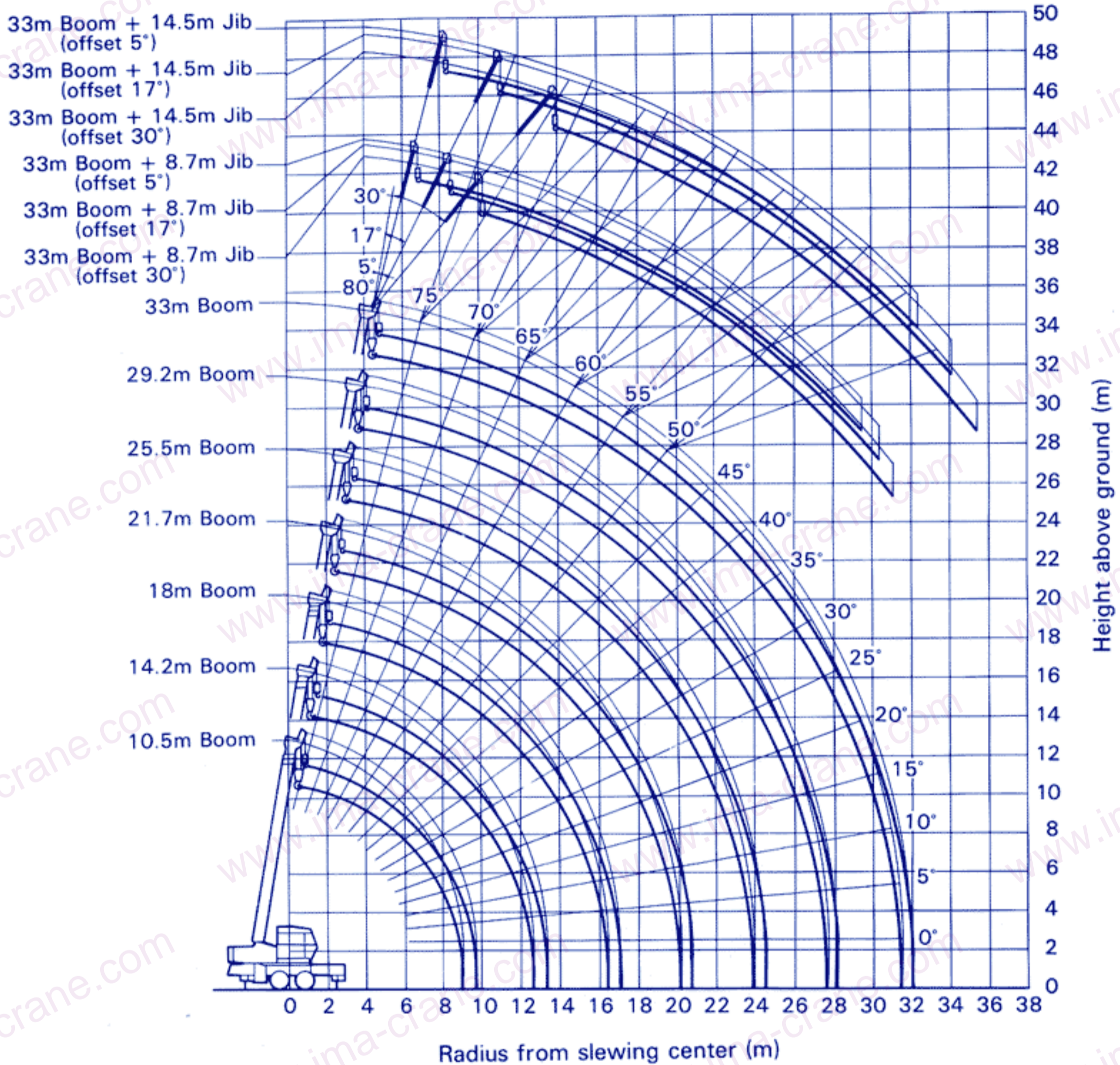

NOTE: Deflection of boom and jib excluded.

شرکت ایمن مرکزی اروند (سهامی خاص)

نماینده رسمی فروش و خدمات پس از فروش
جرثقیل های کاتو و هیلتاچی سومیتومو در ایران

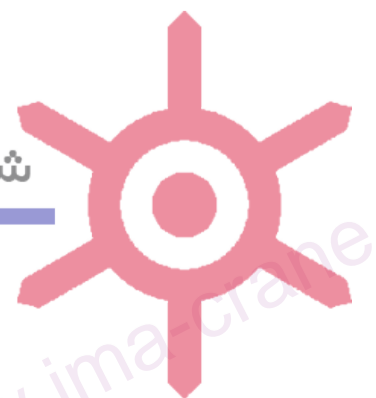

CARRIER SPECIFICATION

■ MITSUBISHI K303LA

General dimensions

Overall length:	approx. 12,580mm
Overall width:	approx. 2,500mm
Overall height:	approx. 3,450mm
Wheel base:	6,400mm (1,450mm + 3,600mm + 1,350mm)
Treads:	Front 2,050mm Rear 1,845mm
Center to center of extended outriggers:	6,100mm (Fully extended) 4,100mm (Intermediately extended)
Gross vehicle weight:	approx. 28,800kg
Front	approx. 9,400kg
Rear	approx. 19,400kg

Carrier

Maker & Model:	MITSUBISHI K303LA
Drive system:	8 x 4
Maximum traveling speed:	65km/h
Gradeability (tanθ):	30% (computed, @G.V.W. = 28,800kg)

Minimum turning radius (center of extreme outer tire): 11.0m

Engine

Maker:	MITSUBISHI
Model:	8DC8-2A
Type:	4 cycle, water cooled, diesel
No. of cylinder:	V - 8
Piston displacement:	14,886cc
Max. output horsepower:	290 PS/2,000 r.p.m. 213 KW/2200 r.p.m.
Max. output torque:	100 kg-m/1,400 r.p.m. 980 N-m/1,400 r.p.m.

NOTE: The output is in accordance with JIS D1004, 1976. Rated power output guaranteed within 5% at standard ambient condition.

Clutch:	Single dry plate, hydraulic control with air booster
Transmission:	5 forward & 1 reverse speed, synchromesh and constantmesh gear Reverse "ELLIOT" type
Axles:	Front Full floating type Rear Full floating type
Steering:	Ball nut type with power booster
Suspension:	Front Semi-elliptic leaf springs Rear Equalizer beams and torque rods
Brake:	Service 2 circuit air brake, 8 wheels internal expanding type Parking & Emergency Spring loaded brake, acting on 4 rear wheels, variable air operated Auxiliary Exhaust brake
Electric system:	24V
Battery:	12V—145F51 x 2
Fuel tank capacity:	200 lit
Driver's cab:	All steel welded construction, 2 persons, low line type, offset left hand side
Tire size:	Front 10.00—20—14PR Rear (dual) 10.00—20—14PR

■ NISSAN DIESEL KG45SXL

General dimensions

Overall length:	approx. 12,580mm
Overall width:	approx. 2,500mm
Overall height:	approx. 3,450mm
Wheel base:	6,350mm (1,520mm + 3,530mm + 1,300mm)
Treads:	Front 2,025mm Rear 1,860mm
Center to center of extended outriggers:	6,100mm (Fully extended) 4,100mm (Intermediately extended)
Gross vehicle weight:	approx. 29,000kg
Front	approx. 9,400kg
Rear	approx. 19,600kg

Carrier

Maker & Model:	NISSAN DIESEL KG45SXL
Drive system:	8 x 4
Maximum traveling speed:	64km/h
Gradeability (tanθ):	33% (computed, @G.V.W. = 29,000kg)

Minimum turning radius (center of extreme outer tire): 10.5m

Engine

Maker:	NISSAN DIESEL
Model:	PE6T
Type:	4 cycle, water cooled, diesel
No. of cylinder:	6-inline
Piston displacement:	11,670cc
Max. output horsepower:	275 PS/2,300 r.p.m. 202 KW/2,300 r.p.m.
Max. output torque:	98 kg-m/1,200 r.p.m. 960 N-m/1,200 r.p.m.

NOTE: The output is in accordance with JIS D1004, 1976.

Clutch:	Single dry plate, hydraulic control with air booster
Transmission:	6 forward & 1 reverse speed, synchromesh and constantmesh gear Reverse "ELLIOT" type
Axles:	Front Full floating type Rear Full floating type
Steering:	Ball nut type with power booster
Suspension:	Front Semi-elliptic leaf springs Rear Equalizer beams and torque rods
Brake:	Service 2 circuit air brake, 8 wheels internal expanding type Parking Mechanical, acting on propeller shaft Auxiliary Exhaust brake
Electric system:	24V
Battery:	12V—115F51 x 2
Fuel tank capacity:	200 lit
Driver's cab:	Steel, two men, semi under floor type one side cab
Tire size:	Front 10.00—20—14PR Rear (dual) 10.00—20—14PR

شرکت ایمن مرکزی اروند (سهامی خاص)

نماینده رسمی فروش و خدمات پس از فروش جرتقیل های کاتو و هیبتاچی سومیتومو در ایران

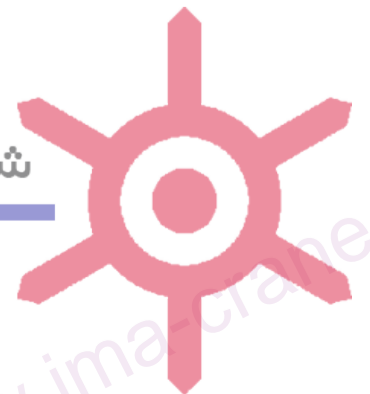

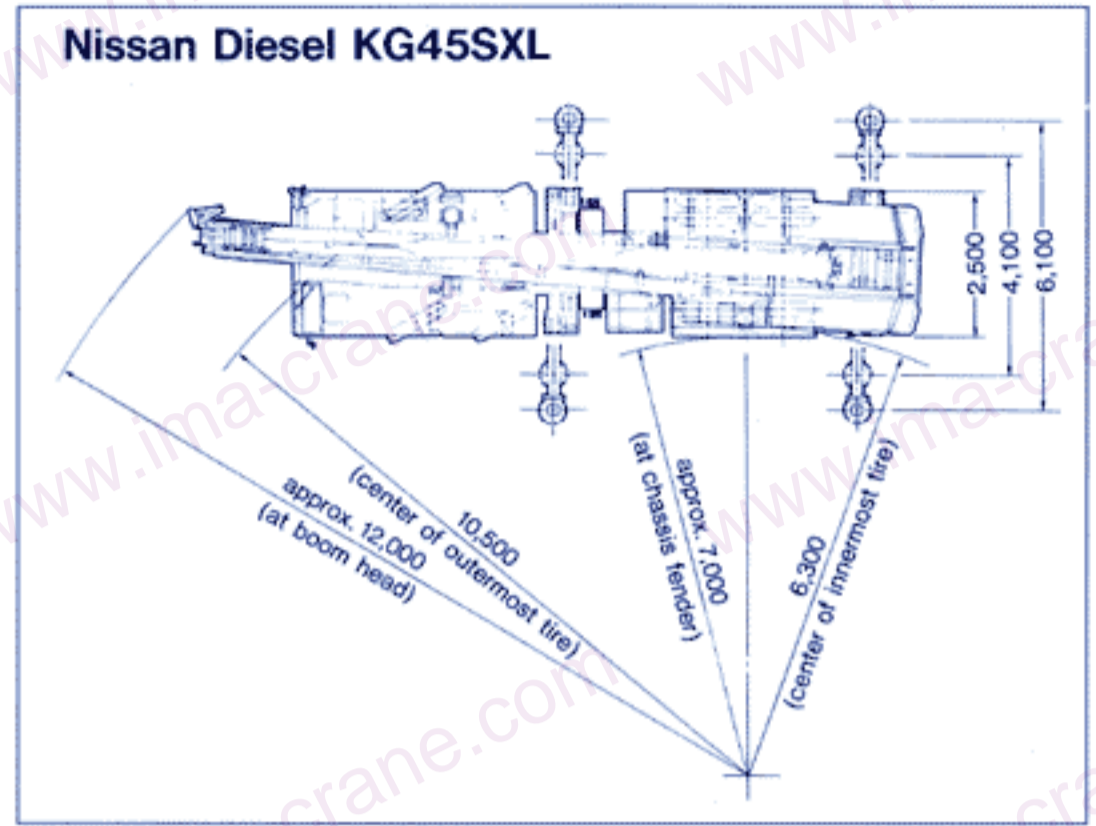
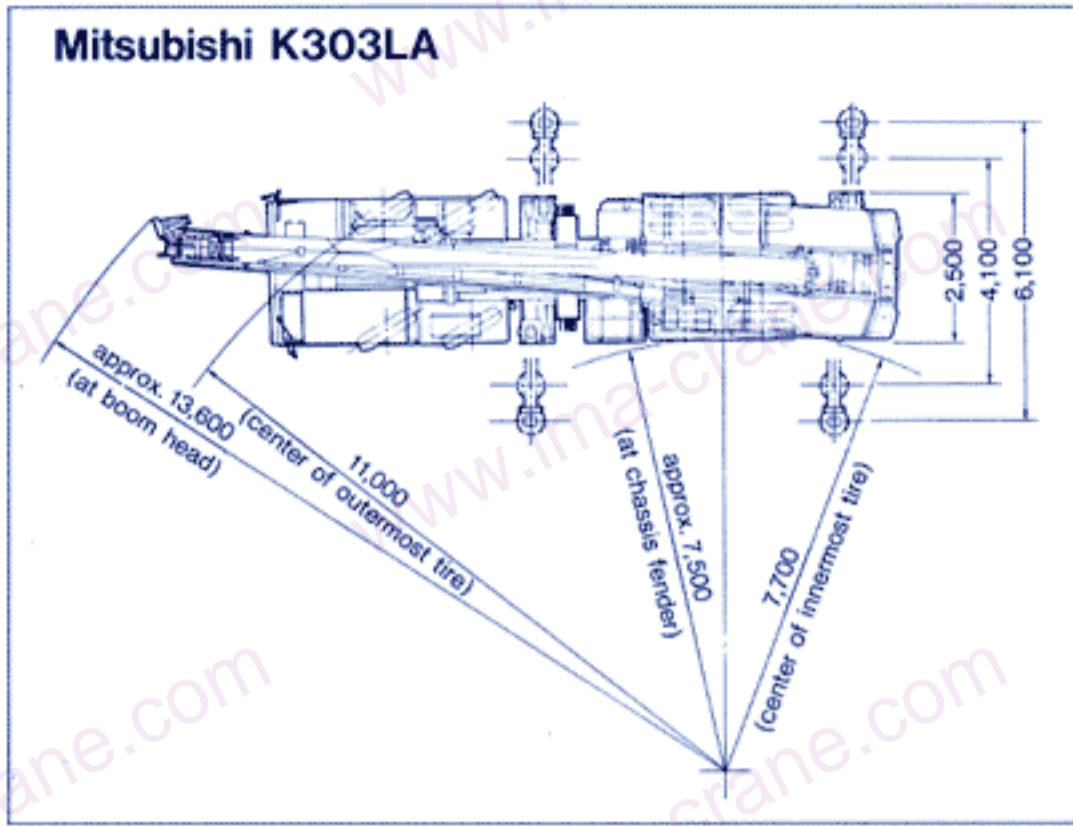

*NOTE: KATO products and specifications are subject to improvements and changes without notice.



KATO WORKS CO., LTD.

9-37, Higashi-ond 1-chome, Shinagawa-ku, Tokyo, 140 Japan
 Phone : Head Office Tokyo (03) 3458-1111
 Overseas Marketing Dept. Tokyo (03) 3458-1115
 Telex 222-4519 (CRKAT) جرتقیل های کاتو و ریسرچ
 Fax : Tokyo (03) 3458-1152
 Cable : CRANEKATO TOKYO

