

HITACHI SUMITOMO

SCX2000A-2

HYDRAULIC CRAWLER CRANE

Specifications

ASIAN ISSUE



Specifications

HITACHI SUMITOMO

SCX2000A-2

Superstructure

UPPER REVOLVING FRAME:

All-welded, precision machined, robust construction. A machined surface provided for mounting load hoist and boom hoist assemblies, and mounting itself on turntable bearing. And pins bail frame with a 10-sheave machinery and single center sheave of a 21.0 D/d ratio for 2x10-part boom hoist reeving.

TURNTABLE BEARING WITH INTERNAL SLEWING GEAR:

Heavy duty, single shear ball type; inner race of turntable bearing with integral, internal slewing (ring) gear bolted to lower frame, and outer race of turntable bearing bolted to upper revolving frame.

CONTROL SYSTEM:

System contains two sets of triplicate tandem valves which direct oil to various machine function and are actuated by control levers via remote controlled hydraulic servo for all motions. Working speeds can be precisely controlled by motorcycle type throttle and pilot-operated arm chair single axis control levers in cooperation with "EPC" controller that varies engine rpm and hyd. pump discharge simultaneously, or varies just hyd. pump discharge while keeping engine rpm via motorcycle type grip throttle. System also takes a specially-tailored unique hydraulic circuit to maximizes drum horsepower, and reduces horsepower loss with eliminating the possibility of engine stall.

Pump control system — By "EPC" controller that provides two modes of engine-pump control.

MODE I:

The "EPC" Controller is normally programmed to vary the engine speed and pump discharge simultaneously. Simply twisting the grip advances the engine to maximum speed and the hydraulic pumps to maximum flow at the same time. This mode is suitable to precision crane work.

MODE II:

By activating a switch, it is able to vary just the pump discharge by means of the grip throttle, while keeping engine speed fixed. Mode II is convenient for operations such as bucket work, where the engine is normally run at full throttle.

A specially-tailored pressure compensating valve —

Utilized in hydraulic circuits to realize a good minute operation of two main, boom hoist and opt. luffing jib hoist drums.

HYDRAULIC SYSTEM:

System provided with three variable displacement axial piston pumps and one fixed displacement duplicate tandem gear pump for both independent and combined operations of all functions. Gear pump also used for system valves and cylinder controls.

Main/aux. crane hoist motors — Variable displacement axial piston motor with counterbalance valve and spring-applied/hydraulically released multiple wet-disc type automatic brake as std.

Boom hoist motor — Variable displacement axial piston type with counterbalance valve and spring-applied/hydraulically released multiple wet-disc type automatic brake.

Tower jib hoist drum motor — Option extra; Variable displacement axial piston motor with counterbalance valve and spring-applied/hydraulically released multiple wet-disc type automatic brake; available for tower jib hoisting / lowering.

Slewing motor — Two; axial piston type with spring-applied/hydraulically released multiple wet-disc type brake; electrically controlled from instrument panel of operator's cab.

Travel motors — Shoe-in design; axial piston motor with brake valve and spring-applied/hydraulically released multiple wet-disc type automatic brake.

Oil cooler — Aluminum-make; located at a part of superstructure as separated from engine radiator together with an independent autocooling fan for better cooling efficiency and heat balance.

Hydraulic oil reservoir — 450 liters capacity.

Kind of hyd. oil — Standardized with ISO VG46 having viscosity ranging from 41.4 thru 50.6mm²/sec at 40°C.

LOAD HOIST ASSEMBLY (w/out free-fall function):

Std.; front and rear main operating drums driven by independent hydraulic motor of bi-directional, variable displacement axial piston motor through a 2-stage planetary reduction gear unit powering the rope drum in either direction for hoisting and lowering load. Both of drums size in same dimension.

Brakes — Spring-applied, power hydraulically released multiple wet-disc type automatic brake; provided within hyd. motor.

Drums — One piece, parallel grooved lagging with locking ratchet wheel cast integral; provided with a drum internal ring gear to mesh with planetary gears of two rows of reduction gear unit which is involute-splined to hyd. motor shaft which is mounted on anti-friction bearing. Available to wind up 58m long cable of 28mm dia. at drum 1st layer.

Drum locks — Electrically controlled pawl.

Drum rollers — Optional extra; available for right cable winding onto drums.

Drum rotation speed controller — Max. rotation speed can be tuned according to arbitrary value that is electrically controlled by dialing, and then varies pump discharge. Available on two main operating drums independently.

Motor swash plate angle setting switch — Available to set motor swash plates of front/rear drum winch motors at a certain angle for easily synchronizing front and rear drum rotation speeds.

LOAD HOIST ASSEMBLY (w/free-fall function):

Optional extra; front and rear main operating drums driven by independent hydraulic motor of bi-directional, variable displacement axial piston motor through a 2-stage planetary reduction gear unit powering the rope drum in either direction for hoisting and lowering load. Reduction gear unit installed within drum inside together with multiple wet-disc brake unit. Both of drums size in same dimension.

Brakes — Multiple wet-disc unit with negative brake design that takes the function of "spring-applied, power hydraulically released", and maintains a high brake safety even if a hydraulic pressure drop in the circuit happens; installed within drum inside together with reduction gear unit. Eliminate clutch, and require no brake maintenance on this brake design.

Brake control — Applies dynamic hydraulic pressure for brake release operation with an extreme light pedaling force.

Brake mode — Available in two modes; one is automatic as suitable for liftcrane operation, and the other is free-fall mode as suitable for bucket operation. Free-fall interlocking is also designed for fail-safe operation.

A forced-oil cooling system — Available in both front and rear drum brake units to keep brake performance even in continuous heavy-duty operations.

Drum rotation speed controller — Max. rotation speed can be tuned according to arbitrary value that is electrically controlled by dialing, and then varies pump discharge. Available on two main operating drums independently.

Motor swash plate angle setting switch — Available to set motor swash plates of front/rear drum winch motors at a certain angle for easily synchronizing front and rear drum rotation speeds.

Drums — One piece, parallel grooved lagging with locking ratchet wheel cast integral; provided with a drum internal ring gear to mesh with planetary gears of first reduction gear unit which is involute-splined to hyd. motor shaft, and final reduction planetary gears meshes with its external ring gears which couples with multiple wet-disc brake unit shaft thru involute-spline. Available to wind up 58m long cable of 28mm dia. at drum 1st layer.

Drum locks — Electrically operated pawl.

Drum rollers — Optional extra; available for right cable winding onto drums.

BOOM HOIST ASSEMBLY:

Twin-drum design; driven by single bi-directional, axial piston hydraulic motor through a 3-stage planetary reduction gear unit powering the rope drum in either direction for hoisting and lowering boom.

Brake — Spring-applied, power hydraulically released multiple wet-disc type automatic brake.

Drum — One piece, twin-design, parallel grooved lagging with locking ratchet wheel cast integral; bolted to planetary reduction gear unit outer case.

Drum lock — Power hydraulically operated automatic pawl.

Drum rotation speed controller — Max. rotation speed can be tuned according to arbitrary value that is electrically controlled by dialing, and then varies pump discharge.

TOWER JIB HOIST DRUM WINCH MECHANISM:

Optional extra; driven by independent hydraulic motor of bi-directional, variable displacement axial piston motor through a 2-stage planetary reduction gear unit powering the rope drum in either direction for hoisting and lowering tower jib.

Brake — Spring-applied, power hydraulically released multiple wet-disc type automatic brake; provided within hyd. motor.

Drum — One piece, parallel grooved lagging with locking ratchet wheel cast integral; provided with a drum internal ring gear to mesh with planetary gear of two rows of reduction gear shaft which is mounted on anti-friction bearing.

Drum lock — Electrically controlled pawl.

Drum rotation speed controller — Max. rotation speed can be tuned according to arbitrary value that is electrically controlled by dialing, and then varies pump discharge.

SLEWING:

Driven by two units of bi-directional, axial piston hydraulic motors through 2 sets of planetary reduction gear unit powering slewing pinion. Slewing pinion meshes with

internal teeth of slewing (ring) gear of turntable bearing inner race.

Brakes — Spring-applied, power hydraulically released multiple wet-disc type; provided on each of hydraulic motor.

Slewing speed controller — Max. slewing speed can be tuned according to arbitrary value that is electrically controlled by dialing, and then varies pump discharge.

Lock — Mechanically operated drop pin.

Speed — 1.7min^{-1} $<1.7\text{rpm}$

OPERATOR'S CAB:

A 2.3mm thickness steel plate construction with 940mm wide and a stamped-and-rounded corner designs; acoustically treated, full-vision, cushion rubber mounted, well-ventilated, full compartment, roomy operator's cab with a large straighted front window with green-tinted safety glass; provided with an arrangement of "EPC" control/slewing lever, armchair control station, sunvisor, sunshade, rear-view mirrors, dual intermittent type window shield wipers with washer on both front and roof windows, sliding windows on both sides of cab, and slewing-link type sliding door.

Instrument panel — Contains engine monitoring lamps, graphic display panel of Load Moment Indicator, gauges & meter, warning lamps and other necessary controllers and switches.

Operator's seat — Full adjustable reclining seat with head rest and both R/H and L/H side arm rests.

Air-conditioner — Provided as std.; built-in type full air-conditioner.

Microphone & loud-speaker — Optional extra; this is for operator's convenience for loud speaking.

Engine foot throttle — Optional extra; available for right-hand foot with electrical control.

Electric outlet — 24V; available in cab.

Operator's cab sidestep cab / frontstep — Available for access ease to operator's cab.

AM/FM radio — Provided as std. with clock.

Fire extinguisher — Optional extra; powder type with 1kg capacity.

Drum brake pedals — Optional extra; correspondingly designed in the case that an optional free-fall function is required on two main operating drums.

MACHINERY CAB:

Equipped with hinged doors on both sides for machinery access and inspection; affixed tape-type non-skid material on the roof.

CATWALKS:

Optional extra; hitched in place along both sides of machinery cab.

HYDRAULIC TAGLINE WINDER:

Optional extra; provided in front of upper revolving frame, and this is available for preventing a shake of suspended load like clamshell bucket by an 10mm dia. tug cable with light force.

COUNTERWEIGHTS:

Weighs 80.6ton consisting of a 17.8ton base weight and a 12-piece cast iron block of 3 pcs. each of "R1"(5.5t), "L1"(5.8t), "R2"(4.6t) and "L2"(5.0t), totally weighing 62.7t.

Note: When 15.25m basic boom only, one piece each of "R2" and "L2" should be deducted.

Counterweight self-removal device — Provided as std.; raises and lowers a 80.6ton full counterweight by a lifting mechanism with two

power hyd. cylinders attached on the base weight.

ELECTRICAL SYSTEM:

24-volt negative ground system; provided with two maintenance free 12-volt batteries.

LIGHTING SYSTEM:

Includes following lights.
 • Two 70 W working lights;
 • One 10 W interior cab light.

REAR VIEW MIRRORS:

Two; each provided on front-left and -right corners of superstructure.

POWER UNIT:

Make & Model	Mitsubishi 6M70-TL
Type	Water-cooled, 4-cycle, direct injection, turbo-charged, diesel w/automatic cooling fan
No. of Cylinders	Six (6)
Bore & Stroke	130 mm × 150 mm
Displacement	12,880 cc
Rated Output	272 kW/2,000 min ⁻¹ (370 ps/2,000 rpm)
Maximum Torque	1,510 N·m/1,600 min ⁻¹ (154 kgf-m/1,600 rpm)
Fuel Tank	500 liters

Notes:

- The engine meets Stage/Tier 3 of current smoke emission regulations in Europe, America and Japan.
- A 272kW engine horsepower shown above is defined under a current international engine horsepower indication formula which includes necessary horsepower for engine alternator drive but excludes engine fan drive.

Undercarriage

LOWER FRAME:

All-welded, precision machined, box type construction; provided with four heavy duty tip blocks w/pins and lugs to hook and then assemble crawler side frames on. To mount turntable bearing, a machined surface is provided too.

LOWER FRAME JACK-UP DEVICE:

Contains four hydraulic jack cylinders attached on lower frame jack cylinder beams which is pinned to lower frame for disassembling/assembling ease of crawler side frames.

Remote control box — Provided for control of lower frame jack cylinders and hyd. removal joints.

Pontoon — All-welded construction; four pontoons each attached on side of jack cylinder beams or lower frame.

CRAWLER SIDE FRAMES:

All-welded, box type construction, precision machined; each provided with two steel plate

hooks for an assembling ease on lower frame. Held in place by hydraulic removal heavy duty joint-pins provided on four tip blocks of lower frame.

Hyd. removal joint-pins — Four; available to hold in place crawler side frames on lower frame with a face-contact design to bear reaction force of crawler side frame. And, four pins are each operated by hyd. cylinder thru remote control box shown in clause of "LOWER FRAME JACK-UP DEVICE" above.

Crawler side steps — Provided at both ends of the frames for easy access to superstructure.

LOWER WEIGHT:

Weighs 27.6ton; made of cast iron. A 13.8ton each hook-mounted on lower frame jack cylinder beams provided at front and rear of the lower frame.

DRIVE SPROCKETS:

Cast steel, heat treated; one per side frame. Track drive sprocket assembly bolt-coupled to 3-stage planetary reduction gear unit outer case as an integral part of shoe-in type traction motor. Sealed between parts of rotation and non-rotation of the motor with floating seal.

IDLER WHEELS:

Cast steel, heat treated; one per side frame. Mounted on two bronze bushings with floating seals for lifetime lubrication.

TRACK ROLLERS:

Twelve per side frame; each heat treated cast steel with double flange design. All rollers mounted on two bronze bushings with floating seals for lifetime lubrication.

CARRIER ROLLERS:

Two each of cantilever and double flange type rollers per side frame; each heat treated cast steel. All rollers mounted on bronze bushings with floating seals for lifetime lubrication.

TRACKS:

Heat treated, self-cleaning, multiple hinged track shoes joined by full floating pins; 55 pcs. per side frame.

Shoe width — 1,120mm wide as standard.

Track adjustment — Manual adjustment device with oil jack and shim plate packs is standardized.

Automatic track tension adjusting device — Optional extra; available instead of std. track adjustment to always keep track tension at optimum level by means of power hyd. cylinder thru idler wheel actuated by power hydraulic supplied from superstructure.

TRAVEL AND STEERING:

A bi-directional, shoe-in type axial piston hydraulic motor bolt-couples drive sprocket thru 3-stage planetary reduction gear unit outer case at each crawler side frame end for travel and steer. Straight-line travel (forward or reverse), pivot or differential turns, and counter-rotation for spin turns are available.

Brake — Spring-applied, hydraulically released multiple wet-disc type automatic brake; located within hydraulic motor. Brakes automatically set when travel levers are in neutral or when engine is shut down.

Travel speed — 1.2/0.6km/hr. (based on flat, level and firm supporting surface, and under the conditions that no load must be applied and front-end att. must be 15.25m basic boom only).

Gradability — 30% (17°) permissible based on basic machine without front-end attachment.

Safety Devices

LOAD MOMENT INDICATOR:

This is a fully computerized automatic over-load preventing system including total safe operation control system; provided with the designs of (1) no zero-point adjustment, (2) data input according to interface counter-indication/message on display panel, and (3) a graphic display panel with setting ease of viewing angle.

Construction (standard version) — Comprises (1) load detecting device with amplifier, (2) boom angle detector, (3) computerized Micro Processing Unit (M.P.U.), and (4) graphic display panel.

Functions — This system functions that if the lifting load reaches 90% of the rated one specified in the crane capacity chart, an intermittent pre-warning buzzer is given; if it is 100%, a warning is given by a continuous buzzer, and all peril side motions are automatically stopped. The machine, however, can be operated in safety side motions.

Display panel design — A graphic display panel is designed, and it is able to input necessary operating conditions/data according to interface counter-indication/message on the display panel, and the display panel indicates ten and some kinds of the present lifting and working conditions/data like "lifting load", "max. allowable lifting load", "working radius", "max. allowable working radius", "boom angle", "load ratio", "boom/jib lengths", "engine rpm" and so on when working. In addition, the display panel is provided with three warning indicators over "engine over-heat", "hyd. oil over-temp." and "brake oil over-temp."

MAIN HOOK OVER-HOISTING LIMITER:

Limit switch type. Available to prevent hook over-hoisting with functions of automatic drum braking with hydraulic lock, and warnings by an alarm.

BOOM OVER-HOISTING AND -LOWERING LIMITER:

Available in two kinds of devices; one is limit switch located on a part of boom foot for preventing boom over-hoisting, and the other is the safety function of the LMI available to automatically prevent boom over-hoisting and -lowering with the functions of automatic drum braking with hydraulic lock, and warnings by an alarm. Further boom protection from rapid boom over-hoist by hook over-hoist motion under mal-function of main hook over-hoisting limiter is available as one of functions of the LMI.

BOOM BACKSTOPS:

Dual; telescopic design with spring buffers.

SECONDRY BOOM OVER-HOISTING LIMITER:

Additional limit switch located on boom backstops; this is as a further safety device for redundant boom protection.

SLEW LOCK:

Mechanically operated drop pin; available to firmly lock superstructure in four positions of facing front or rear or left or right to undercarriage.

DRUM LOCKS:

Electrically operated pawl locks is available on front and rear main drums while power hydraulically operated pawl lock is available on boom hoist drum with an automatic locking device as std.

FREE-FALL INTERLOCKING:

Optional extra: Available on both front and rear main drum brake lines for fail-safe operation. Functions that free-fall brake mode is only available when drum brake pedal is pressed even though brake mode is switched on free-fall mode.

SLEWING BRAKE SAFETY CIRCUIT:

Available not to start engine whenever slewing brake is off.

NON-DRUM BRAKE PREVENTING DEVICE:

Optional extra: Available not to start engine whenever drum brake mode is in "free-fall".

BOOM ANGLE INDICATOR:

Pendulum type; mounted on right-hand side of base section of crane main boom.

HOOK LATCH:

Provided on every kinds of hook to prevent out of place of cable from hook.

LEVEL GAUGE:

Bubble type; located on operator's cab floor and a part of undercarriage.

INDEPENDENT LEVER LOCKS:

Provided on all control levers (except slewing lever) to lock levers in neutral.

SLEWING ALARM:

This is by buzzer, and flasher lamps located on both sides of machinery cab.

SPEED SLOWDOWN DEVICE:

This is for speed slowdown of hoisting and lowering motions of boom which are available just before automatic stopping at both upper and lower side limits of boom angle even though control lever(s) is still at hoisting/lowering position to prevent a shock.

SLEWING BRAKE LAMP:

Provided on operator's cab instrument panel; this is available to confirm whether or not slewing brake is applied.

SIGNAL HORN:

Available as warning just before every kinds of motions are initiated.

LOCK LEVER (FOOL PROOF SHUT-OFF LEVER):

Located in the cab exit; this is available to automatically deactivate and lock hydraulic system.

TRAVEL ALARM:

An intermittent buzzer warns when travel motion is initiated.

ENGINE MONITORING LAMPS:

Available to let operator warn engine abnormal conditions as to battery charge, lubrication oil

pressure, radiator coolant level, oil filter clogging, air filter clogging, water temp., control unit and glow plug.; provided on instrument panel.

FRONT-END ATT. ERECTION MODE:

This is an internal, integral function of the LMI. In the range out of crane working area, the LMI display panel automatically indicates "Now, out of crane working range" with a rigging instruction, and it is available to lift front-end att. off ground without the influence of LMI safety functions, and, after front-end att. is lifted over the range of crane working area, LMI safety function gets back automatically for safe erection work. This function is also available for the work of vice-versa.

LIFTING HEIGHT INDICATION DEVICE:

Available to indicate lifting height above ground or depth below ground on display panel of the LMI. Also, hook hoisting speed slowdown function is available just before automatic stopping at a desired height under hook height setting before operation.

LMI SAFETY CIRCUIT-OFF SWITCH:

Available in key type for a good crane safety operation management without fail.

TRAVEL DIRECTION ARROW:

Attached each on crawler side frames.

GAUGES & METER:

Engine water temperature gauge, fuel gauge and hour-meter are provided on instrument panel.

WARNING LAMPS:

Available to let operator warn abnormal machine conditions as to pilot pressure and brake system of two main and opt. luffing jib hoist drums; provided on instrument panel.

DRUM LIGHT & MIRROR:

Optional extra; available to check rope winding onto front and rear drums from operator's cab.

THREE COLOR PERCENTAGE INDICATOR:

Optional extra; this is with three colors of Green, Yellow and Red. Each color indicates the load percentage to rated capacity; Green shows less than 90% as safety, Yellow shows 90 to 99% as marginal, and Red shows over 100% as over-loading. As further function, Red lamp comes on automatically when operator cuts off safety circuit of LMI absent-mindedly.

ANEMOMETER:

Optional extra; recommended for luffing jib attachment.

AUX. CRANE HOOK OVER-HOISTING LIMITER:

Optional extra; this is available for auxiliary crane hoist with optional short jib and/or fly jib. Performs the same function as that of "Main hook over-hoisting limiter" mentioned before.

In addition to the above, following safety devices are standard for tower jib attachment.

TOWER JIB ANGLE DETECTOR:

This is one of key safety device in a case of tower jib attachment.

TOWER JIB LOAD DETECTOR:

This is also important safety device when luffing towercrane attachment is required.

TOWER JIB OVER-HOISTING AND- LOWERING LIMITER:

Performs all the same function as that of "Main boom over-hoisting and-lowering limiter" stated before.

TOWER JIB HOOK OVER HOISTING LIMITER:

Performs the same function as that of "Main hook over-hoisting limiter" described before.

TOWER JIB BACKSTOPS:

Dual; telescopic design with spring buffers.

SECONDARY TOWER JIB OVER HOISTING LIMITER

Additional limit switch located on tower jib backstops; this is as a further safety device for redundant tower jib protection.

Front-end Attachment

CRANE BOOM:

Lattice construction, round tubular main chords, alloy, hi-ten steel, with bracing of round steel tubing.

Boom connections..... In-line pin connections at 2.10m deep and 2.10m wide.

Basic boom..... Two-piece, 15.24m basic length; 7.62m base and tapered top sections. Provided with boomfoot pin removal cylinders.

Boom head machinery..... Six head sheaves, and two guide sheaves mounted on anti-friction bearings of conventional non-sealed grease type.

Two-hanger sheave block..... Optional extra; pinned to boom head shaft. Sheaves each mounted on anti-friction bearings of conventional non-sealed grease type. Required when lifting load exceeds 160ton, and available up to 200ton lift.

Boom extension..... Optional extra; available in 3.05m, 6.10m and 9.15m with pendants.

Maximum boom length..... 85.40m meters.

Note: All of boom extensions are designed with no intermediate diagonal bracing(s); the diagonal bracing is only designed at one of two picture frames. Accordingly, it is able to nest tower jib extension into appropriate boom extension in length.

FLY JIB:

Optional extra; lattice construction, round tubular main chords, alloy, hi-ten steel, with bracing of round steel tubing having in-line pin connections at 0.8m deep and 0.9m wide, and jib head machinery with single sheave mounted on antifricition bearings of conventional non-grease type. Provided with jib strut, jib backstops, and jib/boom guyline pendants. Mounted on 7.62m tapered top section, and available for light load lifting operation with less than 27ton with two-part hoist line. Single part hoist line is also available for a 13.5ton lift as max.

Basic fly jib..... Two-piece, 12.20m basic length; 6.10m base and top sections.

Fly jib extensions..... Available in 6.10m length with pendants.

Maximum fly jib length..... 30.50m.

Boom plus fly jib length..... Max. 73.20m + 30.50m.

SHORT JIB:

Optional extra; all-welded construction having single sheave head machinery. Pinned to 7.62m tapered top section.

BOOM LIVE MAST:

A 7.925m long; all-welded, box construction. Mounted in front of upper revolving frame, and pins bridle frame with a 10-sheave machinery of a 21.0 D/d ratio for a 2x10-part boom hoist line. Raised by two power hyd. cylinders from transportation position to a certain working position. This is available as a short boom for self-assembling work. In addition, a 2-large diameter single pendant rope of short length with plate link is pinned on top of the mast for easy connection with a 2-dual extender cables.

QUICK-DRAW HYD. CYLINDER W/HOOK:

Optional extra; attached onto boom live mast and available for assembling/disassembling works of a whole machine without helper crane in cooperation with counterweight self-removal device.

HOOK BLOCKS:

- 200/135t, five sheaves plus 2-hanger sheave block with duplex type hook.....Optional extra.
- 160t, six sheaves with duplex type hookOptional extra.
- 120t, five sheaves with duplex type hookOptional extra.
- 80t, three sheaves.....Optional extra.
- 35t, one sheave.....Optional extra.
- 13.5t, ball hook.....Optional extra.

Notes: A 2-hanger sheave block is not attached on 200t/135t hook block, it becomes a 135t hook block.

BAIL AND BRIDLE:

All-welded construction; provided with larger sheaves of a 21.0 D/d ratio on both bail and bridle for 2x10-part boom hoist rope reeving. Bail pinned to upper revolving frame directly, and bridle pinned to boom live mast respectively. And, pendant ropes bridge the gap between boom live mast and 7.62m tapered top section.

DRUM DATA:

Drum	Root dia.	Type	Line speed (Hoisting, Lowering)	Cable	Max. line pull
Front main	596mm	Parallel grooved	110 ~ 2mpm	28mm	245kN (25.0ton)
Rear main	596mm	Parallel grooved	110 ~ 2mpm	28mm	245kN (25.0ton)
Boom hoist	641mm	Parallel grooved	2 x (32 ~ 1.0)mpm	22.4mm	165kN (16.9ton) x 2
Tower jib hoist (opt.)	596mm	Parallel grooved	55 ~ 1mpm	28mm	245kN (25.0ton)
Tower boom hoist	641mm	Parallel grooved	2 x (32 ~ 1.0)mpm	22.4mm	165kN (16.9ton) x 2

Notes:

1. Line speed is based on drum first layer and rated engine rpm with no load.
2. Hoisting line speed varies under load and operating conditions.
3. Crane hoist applications of front and rear main drums shall be upon kind of front-end attachment.

HOIST REEVING:

(ton)

Kind of hook	No. of partline												
	15	13	12	10	9	8	7	6	5	4	3	2	1
200t	200.0	175.0	—	—	—	—	—	—	—	—	—	—	—
160t	—	—	160.0	135.0	121.5	108.0	94.5	81.0	67.5	54.0	—	—	—
135t	—	—	—	135.0	121.5	108.0	94.5	81.0	67.5	54.0	40.5	27.0	13.5
120t	—	—	—	—	120.0	108.0	94.5	81.0	67.5	54.0	40.5	27.0	13.5
80t	—	—	—	—	—	—	—	80.0	67.5	54.0	40.5	27.0	13.5
35t	—	—	—	—	—	—	—	—	—	—	35.0	27.0	13.5
13.5t	—	—	—	—	—	—	—	—	—	—	—	—	13.5

CABLES:

Front drum..... P-S (19)+39xP-7, non-spin type, 28mm dia./410m long, breaking load 755kN (77.0t); available for both of general crane and tower jib crane applications.

Rear drum..... Optional extra; P-S (19)+39xP-7, non-spin type, 28mm dia., breaking load 755kN (77.0t).

Length depends on crane hoist applications as under:

1. Fly jib application..... 300m.
2. Short jib application 185m.
3. Tower jib crane application (used as tower jib hoist drum)..... 185m.

Note:

In the case that rear drum is used for tower jib hoist, it is required to provide the cable as shown below.

XP rope with construction of IWRC 6xP-WS (31), 28mm dia., breaking load 657kN (67.0t).

Boom hoist drum..... XP rope with construction of IWRC 6xP-WS (31), 22.4mm dia./275m long, breaking load 417kN (42.5t).

Liftcrane Capacities 200 metric tons

Boom length (m) Working radius (m)	15.25	18.30	21.35	24.40	27.45	30.50	33.55	36.60	39.65	42.70	45.75	48.80	51.85	54.90	57.95	61.00	64.05
4.6	200.0																
5.0	186.0	175.0/5.1															
5.5	171.0	170.5	160.0/5.7														
6.0	158.0	157.8	157.6	152.5/6.2	135.0/6.7												
7.0	136.6	136.4	136.2	136.0	132.3	120.0/7.2	117.0/7.8										
8.0	118.9	118.7	118.5	118.3	114.6	114.3	113.9	100.7/8.3	94.5/8.8								
9.0	105.2	105.0	104.8	104.6	101.0	100.6	100.2	92.8	92.4	88.1/9.4	80.0/9.9						
10.0	94.0	93.7	93.5	93.3	90.0	89.8	89.3	83.3	82.9	82.6	80.0	73.9/10.4	67.5/11.0	61.2/11.5			
12.0	72.6	76.4	76.5	76.4	73.8	73.5	73.0	68.9	68.5	68.1	68.0	64.0	63.5	60.6	54.0	50.4/12.5	45.1/13.1
14.0	58.5	64.0	64.5	64.4	64.2	61.9	61.5	61.4	58.0	57.7	57.5	54.5	54.0	53.9	51.1	49.0	44.4
16.0	54.1/14.8	53.3	53.7	53.7	53.5	53.2	52.8	52.7	50.1	49.8	49.6	47.2	46.7	46.5	44.4	43.9	42.7
18.0		47.6/17.4	45.9	45.9	45.6	45.4	45.1	45.1	43.9	43.6	43.4	41.4	40.9	40.8	39.0	38.5	38.4
20.0			39.9	39.9	39.6	39.4	39.1	39.0	38.9	38.6	38.4	36.7	36.2	36.1	35.7	34.2	34.0
22.0			39.6/20.1	35.1	34.9	34.7	34.4	34.3	34.0	33.9	33.7	33.5	32.4	32.2	31.8	30.5	30.3
24.0				33.7/22.7	31.0	30.8	30.5	30.5	30.2	30.0	29.8	29.6	29.1	29.0	28.6	27.4	27.2
26.0					28.9/25.3	27.7	27.3	27.2	27.0	26.8	26.7	26.4	26.1	26.0	25.7	24.7	24.6
28.0						25.0	24.7	24.6	24.3	24.1	24.0	23.7	23.3	23.2	23.0	22.7	22.3
30.0							22.4	22.3	22.1	21.8	21.7	21.4	21.1	21.0	20.7	20.4	20.3
32.0								21.8/30.6	20.3	20.1	19.8	19.7	19.5	19.1	19.0	18.7	18.4
34.0									19.2/33.3	18.4	18.2	18.0	17.7	17.3	17.2	17.0	16.7
36.0										17.0/35.9	16.7	16.5	16.2	15.8	15.8	15.5	15.1
38.0											15.3	15.1	14.9	14.5	14.4	14.1	13.8
40.0											15.0/38.6	14.0	13.7	13.3	13.2	13.0	12.6
42.0												13.3/41.2	12.6	12.3	12.1	11.9	11.6
44.0													11.8/43.8	11.3	11.2	10.9	10.6
46.0														10.5	10.3	10.1	9.7
48.0														10.3/46.5	9.6	9.3	8.9
50.0															9.1/49.1	8.6	8.2
52.0																8.0/51.8	7.5
54.0																	7.0
56.0																6.9/54.4	6.2
58.0																	6.0/57.0

Boom length (m) Working radius (m)	67.10	70.15	73.20	76.25	79.30	82.35	85.40
12.0	41.0/13.6						
14.0	40.7	37.1/14.1	32.0/14.7	28.2/15.2	24.7/15.7		
16.0	39.1	35.7	31.4	27.8	24.6	21.7/16.2	18.1/16.8
18.0	37.5	34.2	30.5	27.0	23.8	21.0	17.8
20.0	33.6	32.1	29.4	26.2	23.1	20.3	17.2
22.0	30.0	28.7	28.1	25.4	22.3	19.7	16.7
24.0	26.8	25.7	25.6	24.3	21.7	19.1	16.1
26.0	24.2	23.2	23.1	22.7	20.7	18.3	15.5
28.0	22.0	21.5	20.9	20.5	19.5	17.7	14.9
30.0	20.0	19.5	19.0	18.6	18.2	16.5	14.3
32.0	18.1	17.7	17.2	16.9	16.5	15.3	13.3
34.0	16.3	16.0	15.8	15.4	15.0	14.2	12.3
36.0	14.8	14.5	14.4	14.1	13.6	13.1	11.3
38.0	13.5	13.1	13.1	12.8	12.4	12.0	10.5
40.0	12.3	11.9	11.8	11.6	11.3	10.9	9.6
42.0	11.1	10.8	10.8	10.5	10.1	9.9	8.8
44.0	10.2	9.8	9.8	9.5	9.1	8.9	8.0
46.0	9.3	9.0	8.8	8.6	8.3	8.0	7.3
48.0	8.5	8.1	8.1	7.8	7.5	7.2	6.6
50.0	7.8	7.5	7.4	7.0	6.8	6.5	6.0
52.0	7.1	6.8	6.6	6.4	6.0	5.8	5.4
54.0	6.5	6.1	6.0	5.8	5.5	5.1	4.8
56.0	6.0	5.6	5.5	5.2	4.9	4.6	4.2
58.0	5.4	5.0	5.0	4.6	4.4	4.0	3.7
60.0	5.0/59.7	4.6	4.5	4.1	3.9	3.5	3.2
62.0		4.1	4.0	3.7	3.4	3.1	2.7
64.0		4.1/62.3	3.5	3.3	3.0	2.7	2.3
66.0			3.4/65.0	2.9	2.5	2.3	1.9
68.0				2.6/67.6	2.2	1.9	
70.0					1.8		
72.0					1.8/70.3		

■ WORKING MASS & GROUND CONTACT PRESSURE:

Ground contact pressure is 117kPa (1.20kgf/cm²) under an 196t working mass with 18.30m boom, 200t/135t hook block, 80.6t full counterweight, 27.6t lower weight and 1,120mm wide track shoes while it is 111kPa (1.13kgf/cm²) under an 186t working mass with 15.25m basic boom, 200t/135t hook block, 71.0t counterweight, 27.6t lower weight and 1,120mm wide track shoes.

Notes — Liftcrane capacities

1. Capacities included in these charts are the maximum allowable, and are based on machine standing level on firm supporting surface under ideal job conditions.
2. Capacities are in metric tons, and are rated in accordance with European EN13000 Standards in terms of machine stability and structural strength limitations; the figures surrounded by bold lines are based on factors other than those which would cause a tipping condition.
3. Capacities are based on freely suspended loads and make no allowance for such factors as the effect of wind, sudden stopping of loads, supporting surface conditions, and operating speeds. Operator must reduce load ratings to take such conditions into account. Deduction from rated capacities must be made for weight of hook block, weighted ball/hook, sling, spreader bar, or other suspended gear.
 Hook block weight is as follows:
 200t(135t hook block plus 2-hanger sheave block)2.9ton
 160t 2.2ton 135t 2.6ton 120t 1.7ton
 80t 1.4ton 35t 0.9ton 13.5t 0.6ton
4. All capacities are rated for 360° slewing.
5. Least stable rated condition is over the side.
6. An 80.6ton counterweight and 27.6ton lower weight are required for all capacities on this chart. But when 15.25m basic boom only, one piece each of "R2"(4.6t) and "L2"(5.0t) upper counterweight should be deducted.
7. When 15.25m basic boom, kind of hook block should be 160t or greater. and in the case of 18.30m boom, it should be 80t or greater.
8. Attachment must be erected and lowered over the ends of the crawler mounting.
9. Main boom length must not exceed 85.40m.
 Maximum fly jib length permitted — 30.50m.
 Maximum boom plus fly jib combination length permitted — 73.20m+30.50m.
 Maximum boom length when mounting short jib is 82.35m.
10. Capacities when handling load off main boom head sheaves in case of mounting fly jib or short jib on top of boom are detailed; if required, please consult us or nearest distributor.
11. Boom combination shall be in accordance with manufacturer's standard described here in "Boom Combination Diagram" of this specification.

SCX2000A-2 SHORT JIB CAPACITIES: Max. 13.5ton

Note: Jib capacities are almost equal to the figures made by the deduction of approx. 600kg from the liftcrane capacities for boom length up to 82.35m unless restricted by the maximum jib capacity shown above. As to the details, please consult us or nearest distributor.

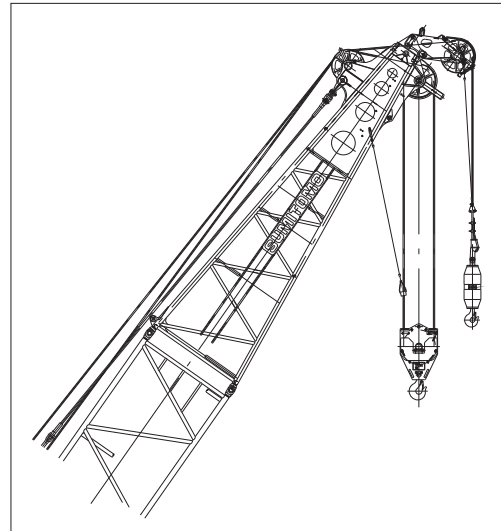

Short jib (Option)

Fly Jib Capacities 27 metric tons

Boom length(m)		36.60							
Jib length(m)		12.20		18.30		24.40		30.50	
Jib offset angle(°)		10		30		10		30	
Working radius(m)		10		30		10		30	
11.9	27.0								
12.0	27.0	13.5/12.2							
14.0	27.0	13.5	13.5/15.5	23.0/14.7	13.5/14.9				
16.0	27.0	13.5	13.5	21.7	13.5		13.5/17.4		
18.0	27.0	13.5	13.5	19.9	13.5	9.0/19.6	13.5		9.1/19.5
20.0	25.0	13.5	12.7	18.4	13.5	9.0	13.5		9.0
22.0	23.2	13.5	12.1	17.2	13.5	9.0	13.5	7.0/23.5	8.7
24.0	21.6	13.5	11.6	16.1	13.5	9.0	13.5	7.0	8.4
26.0	20.2	13.5	11.2	15.1	13.5	8.8	13.5	7.0	8.1
28.0	19.0	13.5	10.8	14.2	13.5	8.6	13.1	6.8	7.9
30.0	18.0	13.5	10.5	13.4	13.4	8.4	12.8	6.6	7.6
34.0	16.2	13.5	10.0	12.1	12.1	8.0	11.6	6.2	7.2
38.0	14.8	13.5	9.6	11.1	11.1	7.6	10.4	5.8	6.8
42.0	13.6	13.5	9.2	10.2	10.2	7.2	9.5	5.6	6.5
46.0	12.7/44.3	12.5/45.0	9.0/45.8	9.5	9.5	6.8	8.7	5.4	6.2
50.0				8.9	8.9	6.4	8.0	5.2	5.9
54.0				8.9/50.2	8.9/51.0	6.2/51.9	7.5	5.0	5.7
58.0							7.2/56.8	4.8	5.5
62.0									5.3
66.0									5.3/62.6
66.0									3.6/64.1
No. of part line	2	1	1	2	1	1	1	1	1

Boom length(m)		39.65							
Jib length(m)		12.20		18.30		24.40		30.50	
Jib offset angle(°)		10		30		10		30	
Working radius(m)		10		30		10		30	
12.5	27.0	13.5/12.7							
14.0	27.0	13.5		22.9/15.2	13.5/15.5				
16.0	27.0	13.5	13.5	22.2	13.5		13.5/17.9		
18.0	27.0	13.5	13.5	20.4	13.5		13.5		
20.0	26.0	13.5	12.7	19.0	13.5	9.0/20.2	13.5		9.1
22.0	24.1	13.5	12.1	17.7	13.5	9.0	13.5		8.8
24.0	22.5	13.5	11.6	16.6	13.5	9.0	13.5	7.0	8.5
26.0	21.1	13.5	11.2	15.6	13.5	8.8	13.5	7.0	8.2
28.0	19.9	13.5	10.8	14.7	13.5	8.6	13.3	6.8	8.0
30.0	18.8	13.5	10.5	13.9	13.5	8.4	13.0	6.6	7.7
34.0	16.9	13.5	10.0	12.6	12.6	8.0	12.0	6.2	7.3
38.0	15.4	13.5	9.6	11.5	11.5	7.6	10.8	5.8	6.9
42.0	13.5	13.5	9.2	10.6	10.6	7.2	9.9	5.6	6.6
46.0	11.7	11.7	8.9	9.9	9.9	6.8	9.0	5.4	6.3
50.0	11.3/46.9	11.2/47.6	8.8/48.4	9.2	9.2	6.4	8.4	5.2	6.0
54.0				8.9/52.9	8.9/53.6	6.0	7.8	5.0	5.8
58.0						6.0/54.5	7.3	4.8	5.6
62.0							7.2/59.5	4.7/60.6	5.4
66.0									5.2/65.2
66.7									3.5
No. of part line	2	1	1	2	1	1	1	1	1

Boom length(m)		42.70							
Jib length(m)		12.20		18.30		24.40		30.50	
Jib offset angle(°)		10		30		10		30	
Working radius(m)		10		30		10		30	
13.0	27.0	13.5/13.2							
14.0	27.0	13.5		22.9/15.7					
16.0	27.0	13.5	13.5/16.6	22.6	13.5				
18.0	27.0	13.5	13.5	20.9	13.5		13.5/18.4		
20.0	26.9	13.5	12.9	19.5	13.5	9.0/20.7	13.5		9.1/20.5
22.0	25.0	13.5	12.4	18.2	13.5	9.0	13.5		8.9
24.0	23.4	13.5	12.0	17.0	13.5	9.0	13.5	7.0/24.6	8.6
26.0	21.9	13.5	11.6	16.1	13.5	8.8	13.5	7.0	8.3
28.0	20.7	13.5	11.2	15.2	13.5	8.6	13.5	6.8	8.1
30.0	19.5	13.5	10.8	14.4	13.5	8.4	13.1	6.6	7.8
34.0	17.6	13.5	10.3	13.0	13.0	8.0	12.4	6.2	7.4
38.0	15.5	13.5	9.8	11.9	11.9	7.6	11.2	5.8	7.0
42.0	13.2	13.2	9.3	11.0	11.0	7.2	10.2	5.6	6.7
46.0	11.3	11.3	9.0	10.2	10.2	6.8	9.4	5.4	6.4
50.0	10.0/49.6	10.0	8.8	9.6	9.6	6.4	8.7	5.2	6.1
54.0		9.9/50.3	8.8/51.1	8.9	8.9	6.0	8.1	5.0	5.9
58.0				8.5/55.5	8.5/56.2	5.7/57.2	7.6	4.8	5.7
62.0							7.2	4.6	5.5
66.0							7.1/62.1	4.5/63.3	5.3
70.0									5.2/67.9
No. of part line	2	1	1	2	1	1	1	1	1

Boom length(m)		45.75									
Jib length(m)		12.20			18.30			24.40		30.50	
Jib offset angle(°)		10		30	10		30	10	30	10	30
Working radius(m)		10		30	10		30	10	30	10	30
13.5	27.0	13.5/13.8									
14.0	27.0	13.5									
16.0	27.0	13.5	13.5/17.1	22.8/16.3	13.5/16.5						
18.0	27.0	13.5	13.5	21.4	13.5		13.5/18.9				
20.0	27.0	13.5	12.7	19.9	13.5	9.0/21.2	13.5			9.1/21.1	
22.0	25.8	13.5	12.1	18.6	13.5	9.0	13.5			9.0	
24.0	24.2	13.5	11.6	17.5	13.5	9.0	13.5	7.0/25.1		8.7	
26.0	22.7	13.5	11.2	16.5	13.5	8.8	13.5	7.0		8.4	
28.0	21.4	13.5	10.8	15.6	13.5	8.6	13.5	6.8		8.2	5.4/28.7
30.0	20.3	13.5	10.5	14.8	13.5	8.4	13.3	6.6		7.9	5.3
32.0	19.3	13.5	10.2	14.1	13.5	8.1	13.0	6.4		7.7	5.2
34.0	18.1	13.5	10.0	13.4	13.4	7.9	12.7	6.2		7.5	5.1
36.0	16.5	13.5	9.8	12.8	12.8	7.6	12.2	6.0		7.3	5.0
38.0	15.2	13.5	9.6	12.3	12.3	7.5	11.6	5.8		7.1	4.9
40.0	14.0	13.5	9.4	11.8	11.8	7.3	11.1	5.7		6.9	4.8
44.0	11.9	11.9	9.0	10.9	10.9	7.0	10.1	5.5		6.6	4.6
48.0	10.2	10.2	8.8	10.2	10.2	6.6	9.3	5.3		6.3	4.4
52.0	8.9	8.9	8.6	9.3	9.3	6.2	8.7	5.0		6.1	4.1
56.0	8.8/52.2	8.8/52.9	8.6/53.7	8.1	8.1	5.8	8.1	4.8		5.9	3.9
60.0				7.5/58.2	7.5/58.9	5.4/59.8	7.5	4.6		5.7	3.7
64.0							6.6	4.4		5.5	3.5
68.0							6.5/64.7	4.3/65.9		5.3	3.3
72.0										5.2/70.5	3.1
No. of part line	2	1	1	2	1	1	1	1	1	1	1

Boom length(m)		48.80									
Jib length(m)		12.20			18.30			24.40		30.50	
Jib offset angle(°)		10		30	10		30	10	30	10	30
Working radius(m)		10		30	10		30	10	30	10	30
14.1	27.0	13.5/14.3									
16.0	27.0	13.5	13.5/17.6	22.8/16.8	13.5/17.0						
18.0	27.0	13.5	13.5	21.8	13.5		13.5/19.5				
20.0	27.0	13.5	12.9	20.4	13.5	9.0/21.8	13.5			9.1/21.6	
22.0	26.6	13.5	12.4	19.1	13.5	9.0	13.5			9.0	
24.0	25.0	13.5	11.9	17.9	13.5	9.0	13.5	7.0/25.6		8.8	
26.0	23.5	13.5	11.5	16.9	13.5	8.8	13.5	7.0		8.5	
28.0	22.2	13.5	11.1	16.0	13.5	8.6	13.5	6.8		8.2	5.3/29.2
30.0	21.0	13.5	10.7	15.2	13.5	8.4	13.4	6.6		8.0	5.3
32.0	19.6	13.5	10.4	14.5	13.5	8.2	13.1	6.4		7.8	5.2
34.0	17.9	13.5	10.1	13.8	13.5	8.0	12.8	6.2		7.6	5.1
36.0	16.3	13.5	9.9	13.2	13.2	7.8	12.6	6.0		7.4	5.0
38.0	14.9	13.5	9.7	12.7	12.7	7.6	12.0	5.8		7.2	4.9
40.0	13.7	13.5	9.5	12.2	12.2	7.4	11.4	5.7		7.0	4.8
44.0	11.7	11.7	9.2	11.3	11.3	7.0	10.5	5.5		6.7	4.6
48.0	10.0	10.0	8.9	10.5	10.5	6.6	9.7	5.3		6.4	4.4
52.0	8.6	8.6	8.7	9.0	9.0	6.2	9.0	5.1		6.2	4.2
56.0	7.8/54.8	7.7/55.6	7.7	7.8	7.8	5.8	8.4	4.9		6.0	4.0
60.0			7.6/56.3	6.8	6.8	5.4	7.3	4.7		5.8	3.8
64.0				6.6/60.8	6.6/61.5	5.2/62.4	6.4	4.5		5.6	3.6
68.0							5.7/67.4	4.3		5.4	3.4
72.0								4.3/68.5		5.1	3.2
74.6										4.9/73.1	3.1
No. of part line	2	1	1	2	1	1	1	1	1	1	1

Boom length(m)		51.85									
Jib length(m)		12.20			18.30			24.40		30.50	
Jib offset angle(°)		10		30	10		30	10	30	10	30
Working radius(m)		10		30	10		30	10	30	10	30
14.6	27.0	13.5/14.8									
16.0	27.0	13.5		22.8/17.3	13.5/17.6						
18.0	27.0	13.5	13.5/18.1	22.2	13.5						
20.0	27.0	13.5	12.9	20.8	13.5		13.5				
22.0	27.0	13.5	12.4	19.5	13.5	9.0/22.3	13.5			9.1/22.1	
24.0	25.7	13.5	12.0	18.4	13.5	9.0	13.5			8.8	
26.0	24.2	13.5	11.6	17.4	13.5	9.0	13.5	7.0/26.1		8.6	
28.0	22.9	13.5	11.3	16.5	13.5	8.8	13.5	7.0		8.3	5.3/29.7
30.0	21.3	13.5	11.0	15.6	13.5	8.6	13.5	6.8		8.1	5.3
32.0	19.2	13.5	10.7	14.9	13.5	8.3	13.3	6.6		7.9	5.2
34.0	17.5	13.5	10.4	14.2	13.5	8.1	13.0	6.4		7.7	5.1
36.0	15.9	13.5	10.1	13.6	13.5	7.9	12.7	6.2		7.5	5.0
38.0	14.6	13.5	9.9	13.1	13.1	7.7	12.4	6.0		7.3	4.9
40.0	13.3	13.3	9.7	12.5	12.5	7.5	11.8	5.8		7.1	4.8
44.0	11.3	11.3	9.3	11.6	11.6	7.1	10.8	5.6		6.8	4.6
48.0	9.6	9.6	9.0	10.1	10.1	6.8	10.0	5.4		6.5	4.4
52.0	8.2	8.2	8.4	8.6	8.6	6.4	9.3	5.2		6.3	4.2
56.0	7.0	7.0	7.1	7.4	7.4	6.0	8.0	5.0		6.1	4.0
60.0	6.6/57.5	6.6/58.2	6.5/59.0	6.4	6.4	5.6	7.0	4.8		5.9	3.8
64.0				5.7/63.4	5.7	5.2	6.0	4.6		5.7	3.6
68.0					5.7/64.2	5.0/65.1	5.2	4.4		5.5	3.4
72.0								4.2/71.2		4.8	3.2
76.0										4.2/75.8	3.0
78.0											2.9/77.3
No. of part line	2	1	1	2	1	1	1	1	1	1	1

Boom length(m)	54.90							
Jib length(m)	12.20		18.30		24.40		30.50	
Jib offset angle(°)	10		30		10		30	
Working radius(m)	10	30	10	30	10	30	10	30
15.1	27.0	13.5/15.3						
16.0	27.0	13.5		22.8/17.8				
18.0	27.0	13.5	13.5/18.7	22.6	13.5/18.1			
20.0	27.0	13.5	13.0	21.2	13.5		13.5/20.5	
22.0	27.0	13.5	12.6	19.9	13.5	9.0/22.8	13.5	
24.0	26.5	13.5	12.2	18.8	13.5	9.0	13.5	9.1/22.7
26.0	24.9	13.5	11.8	17.8	13.5	9.0	13.5	7.0/26.7
28.0	23.1	13.5	11.4	16.8	13.5	8.8	13.5	7.0
30.0	21.1	13.5	11.2	16.0	13.5	8.6	13.5	6.8
32.0	19.1	13.5	10.9	15.3	13.5	8.4	13.4	6.6
34.0	17.3	13.5	10.6	14.6	13.5	8.2	13.1	6.4
36.0	15.8	13.5	10.3	14.0	13.5	8.0	12.9	6.2
38.0	14.4	13.5	10.0	13.4	13.4	7.8	12.6	6.0
40.0	13.2	13.2	9.8	12.9	12.9	7.6	12.1	5.8
42.0	12.1	12.1	9.6	12.4	12.4	7.4	11.6	5.7
44.0	11.1	11.1	9.5	11.7	11.7	7.2	11.1	5.6
46.0	10.2	10.2	9.3	10.7	10.7	7.0	10.7	5.5
48.0	9.4	9.4	9.2	9.9	9.9	6.8	10.3	5.4
50.0	8.7	8.7	8.9	9.2	9.2	6.6	9.8	5.3
54.0	7.4	7.4	7.6	7.8	7.8	6.2	8.5	5.1
58.0	6.3	6.3	6.4	6.7	6.7	5.8	7.3	4.9
62.0	5.8/60.1	5.8/60.8	5.7/61.6	5.8	5.8	5.4	6.3	4.7
66.0				4.9	4.9	5.0	5.4	4.5
70.0				4.9/66.1	4.9/66.8	4.9/67.7	4.7	4.3
74.0							4.2/72.7	4.1/73.8
78.0								3.6
80.0								3.6/78.4
No. of part line	2	1	1	2	1	1	1	1

Boom length(m)	57.95							
Jib length(m)	12.20		18.30		24.40		30.50	
Jib offset angle(°)	10		30		10		30	
Working radius(m)	10	30	10	30	10	30	10	30
15.6	27.0	13.5/15.9						
16.0	27.0	13.5						
18.0	27.0	13.5	13.5/19.2	22.7/18.4	13.5/18.6			
20.0	27.0	13.5	13.0	21.6	13.5		13.5/21.1	
22.0	27.0	13.5	12.6	20.3	13.5	9.0/23.3	13.5	
24.0	26.9	13.5	12.3	19.1	13.5	9.0	13.5	9.1/23.2
26.0	24.4	13.5	12.0	18.1	13.5	9.0	13.5	7.0/27.2
28.0	22.2	13.5	11.7	17.2	13.5	8.8	13.5	7.0
30.0	20.6	13.5	11.4	16.4	13.5	8.6	13.5	6.8
32.0	18.8	13.5	11.1	15.6	13.5	8.4	13.5	6.6
34.0	17.0	13.5	10.8	15.0	13.5	8.2	13.2	6.4
36.0	15.5	13.5	10.5	14.3	13.5	8.0	13.0	6.2
38.0	14.1	13.5	10.3	13.8	13.5	7.8	12.7	6.0
40.0	12.9	12.9	10.0	13.2	13.2	7.6	12.5	5.8
42.0	11.8	11.8	9.8	12.4	12.4	7.4	11.9	5.7
44.0	10.8	10.8	9.6	11.4	11.4	7.2	11.5	5.6
46.0	9.9	9.9	9.5	10.5	10.5	7.0	11.0	5.5
48.0	9.1	9.1	9.4	9.6	9.6	6.8	10.3	5.4
50.0	8.4	8.4	8.7	8.9	8.9	6.6	9.5	5.3
54.0	7.1	7.1	7.3	7.5	7.5	6.2	8.2	5.1
58.0	6.0	6.0	6.1	6.4	6.4	5.8	7.0	4.9
62.0	5.1	5.1	5.2	5.4	5.4	5.4	6.0	4.7
66.0	4.9/62.8	4.9/63.5	4.8/64.3	4.6	4.6	5.0	5.1	4.5
70.0				4.1/68.7	4.1/69.5	4.2	4.4	4.3
74.0						4.1/70.4	3.7	3.9
78.0							3.5/75.3	3.4/76.5
82.0								2.9/81.1
No. of part line	2	1	1	2	1	1	1	1

Boom length(m)	61.00							
Jib length(m)	12.20		18.30		24.40		30.50	
Jib offset angle(°)	10		30		10		30	
Working radius(m)	10	30	10	30	10	30	10	30
16.2	27.0	13.5/16.4						
18.0	27.0	13.5	13.0/19.7	22.7/18.9	13.5/19.2			
20.0	27.0	13.5	13.0	21.9	13.5		13.5/21.6	
22.0	27.0	13.5	12.7	20.6	13.5	9.0/23.9	13.5	
24.0	26.7	13.5	12.4	19.5	13.5	9.0	13.5	9.1/23.7
26.0	24.1	13.5	12.0	18.5	13.5	9.0	13.5	7.0/27.7
28.0	21.9	13.5	11.7	17.6	13.5	8.8	13.5	7.0
30.0	19.9	13.5	11.4	16.8	13.5	8.6	13.5	6.8
32.0	18.2	13.5	11.1	16.0	13.5	8.4	13.5	6.6
34.0	16.7	13.5	10.9	15.3	13.5	8.2	13.4	6.4
36.0	15.3	13.5	10.7	14.7	13.5	8.0	13.1	6.2
38.0	13.9	13.5	10.5	14.1	13.5	7.8	12.9	6.0
40.0	12.7	12.7	10.2	13.3	13.3	7.6	12.6	5.8
42.0	11.6	11.6	10.0	12.2	12.2	7.4	12.3	5.7
44.0	10.6	10.6	9.8	11.2	11.2	7.2	11.8	5.6
46.0	9.7	9.7	9.6	10.2	10.2	7.0	11.0	5.5
48.0	8.9	8.9	9.2	9.4	9.4	6.8	10.1	5.4
50.0	8.1	8.1	8.4	8.6	8.6	6.6	9.3	5.3
54.0	6.8	6.8	7.1	7.3	7.3	6.2	8.0	5.1
58.0	5.7	5.7	5.9	6.2	6.2	5.8	6.8	4.9
62.0	4.8	4.8	4.9	5.2	5.2	5.4	5.8	4.7
66.0	4.1/65.4	4.1	4.0	4.3	4.3	4.8	4.9	4.5
70.0		4.1/66.1	4.0/66.9	3.6	3.6	4.0	4.1	4.3
74.0				3.4/71.1	3.4/72.1	3.4/73.0	3.5	3.7
78.0							2.9/77.9	3.0
82.0								2.8/79.1
86.0								2.3/83.7
No. of part line	2	1	1	2	1	1	1	1

Boom length(m)		64.05							
Jib length(m)		12.20		18.30		24.40		30.50	
Jib offset angle(°)		10		30		10		30	
Working radius(m)		10		30		10		30	
16.7	26.8	13.5/16.9							
18.0	26.5	13.5		22.7/19.4	13.5/19.7				
20.0	26.0	13.5	13.0/20.3	22.3	13.5				
22.0	25.5	13.5	12.8	21.0	13.5		13.5/22.1		
24.0	24.9	13.5	12.5	19.9	13.5	9.0/24.4	13.5	9.0/24.3	
26.0	23.7	13.5	12.2	18.9	13.5	9.0	13.5	8.8	
28.0	21.5	13.5	11.9	17.9	13.5	8.8	13.5	7.0/28.3	8.6
30.0	19.5	13.5	11.6	17.1	13.5	8.6	13.5	6.8	8.4
32.0	17.8	13.5	11.3	16.3	13.5	8.4	13.5	6.6	8.2
34.0	16.3	13.5	11.0	15.7	13.5	8.2	13.5	6.4	8.0
36.0	14.9	13.5	10.7	15.0	13.5	8.0	13.2	6.2	7.8
38.0	13.6	13.5	10.5	14.2	13.5	7.8	13.0	6.0	7.6
40.0	12.4	12.4	10.3	13.0	13.0	7.6	12.8	5.8	7.5
42.0	11.3	11.3	10.1	11.9	11.9	7.4	12.5	5.7	7.3
44.0	10.3	10.3	10.0	10.9	10.9	7.2	11.6	5.6	7.2
46.0	9.4	9.4	9.8	10.0	10.0	7.0	10.7	5.5	7.0
48.0	8.6	8.6	9.0	9.1	9.1	6.8	9.9	5.4	6.9
50.0	7.8	7.8	8.2	8.4	8.4	6.6	9.1	5.3	6.7
54.0	6.5	6.5	6.8	7.0	7.0	6.2	7.7	5.1	6.5
58.0	5.4	5.4	5.6	5.9	5.9	5.8	6.5	4.9	6.3
62.0	4.5	4.5	4.6	4.9	4.9	5.5	5.5	4.7	5.8
66.0	3.7	3.7	3.8	4.0	4.0	4.5	4.6	4.5	4.9
70.0	3.3/68.1	3.3/68.8	3.2/69.5	3.3	3.3	3.7	3.9	4.2	4.1
74.0				2.7	2.7	3.0	3.2	3.4	3.5
78.0					2.7/74.7	2.7/75.7	2.6	2.8	2.8
82.0							2.2/80.6	2.2/81.8	2.3
86.0									1.8
87.4									1.8
No. of part line	2	1	1	2	1	1	1	1	1

Boom length(m)		67.10							
Jib length(m)		12.20		18.30		24.40		30.50	
Jib offset angle(°)		10		30		10		30	
Working radius(m)		10		30		10		30	
17.2	23.5	13.5/17.5							
18.0	23.3	13.5							
20.0	22.8	13.5	13.0/20.8	22.5	13.5/20.2				
22.0	22.4	13.5	12.8	21.3	13.5		13.5/22.7		
24.0	21.9	13.5	12.5	20.2	13.5	9.0/24.9	13.5	9.0/24.8	
26.0	21.3	13.5	12.2	19.2	13.5	9.0	13.5	8.9	
28.0	20.8	13.5	11.9	18.3	13.5	8.8	13.5	7.0/28.8	8.7
30.0	19.3	13.5	11.6	17.4	13.5	8.6	13.5	6.8	8.4
32.0	17.6	13.5	11.3	16.7	13.5	8.4	13.5	6.6	8.2
34.0	16.1	13.5	11.0	16.0	13.5	8.2	13.5	6.4	8.1
36.0	14.7	13.5	10.7	15.0	13.5	8.0	13.3	6.2	7.9
38.0	13.5	13.5	10.5	13.8	13.5	7.8	13.1	6.0	7.7
40.0	12.2	12.2	10.3	12.7	12.7	7.6	12.9	5.8	7.5
42.0	11.1	11.1	10.1	11.7	11.7	7.4	12.4	5.7	7.4
44.0	10.1	10.1	10.0	10.7	10.7	7.2	11.5	5.6	7.2
46.0	9.2	9.2	9.7	9.8	9.8	7.0	10.6	5.5	7.1
48.0	8.4	8.4	8.8	9.0	9.0	6.8	9.7	5.4	6.9
50.0	7.7	7.7	8.0	8.2	8.2	6.6	8.9	5.3	6.8
54.0	6.4	6.4	6.7	6.8	6.8	6.2	7.6	5.1	6.6
58.0	5.2	5.2	5.5	5.7	5.7	5.8	6.4	4.9	6.4
62.0	4.3	4.3	4.5	4.7	4.7	5.3	5.4	4.7	5.7
66.0	3.4	3.4	3.6	3.9	3.9	4.4	4.5	4.5	4.8
70.0	2.7	2.7	2.8	3.1	3.1	3.6	3.7	4.1	4.0
74.0	2.6/70.7	2.6/71.4	2.6/72.2	2.5	2.5	2.8	3.0	3.3	3.3
78.0				2.1/76.7	2.1/77.4	2.2	2.4	2.6	2.7
82.0						2.1/78.3	1.8	2.0	2.1
86.0							1.8/82.4	1.8/83.6	1.8/84.4
86.3									1.8
No. of part line	2	1	1	2	1	1	1	1	1

Boom length(m)		70.15							
Jib length(m)		12.20		18.30		24.40		30.50	
Jib offset angle(°)		10		30		10		30	
Working radius(m)		10		30		10		30	
17.8	20.4								
18.0	20.4	13.5							
20.0	19.9	13.5	13.0/21.3	19.5/20.5	13.5/20.7				
22.0	19.5	13.5	12.8	19.2	13.5		13.5/23.2		
24.0	19.1	13.5	12.5	18.8	13.5	9.0/25.5	13.5	9.0/25.3	
26.0	18.6	13.5	12.2	18.4	13.5	9.0	13.5	8.9	
28.0	18.1	13.5	11.9	17.9	13.5	8.8	13.5	7.0/29.3	8.7
30.0	17.6	13.5	11.6	17.5	13.5	8.6	13.5	6.8	8.5
32.0	16.8	13.5	11.4	17.0	13.5	8.4	13.5	6.6	8.3
34.0	15.3	13.5	11.2	15.9	13.5	8.2	13.5	6.4	8.1
36.0	14.2	13.5	11.0	14.6	13.5	8.0	13.5	6.2	7.9
38.0	13.0	13.0	10.8	13.4	13.4	7.8	13.2	6.0	7.8
40.0	11.9	11.9	10.6	12.3	12.3	7.6	12.9	5.8	7.6
42.0	10.8	10.8	10.4	11.2	11.2	7.4	11.9	5.7	7.4
44.0	9.8	9.8	10.1	10.3	10.3	7.2	11.1	5.6	7.3
46.0	8.9	8.9	9.4	9.5	9.5	7.0	10.3	5.5	7.2
48.0	8.1	8.1	8.5	8.6	8.6	6.8	9.4	5.4	7.0
50.0	7.3	7.3	7.7	7.9	7.9	6.6	8.6	5.3	6.9
54.0	6.0	6.0	6.3	6.5	6.5	6.2	7.3	5.1	6.6
58.0	4.9	4.9	5.2	5.4	5.4	5.8	6.1	4.9	6.4
62.0	3.9	3.9	4.1	4.4	4.4	5.0	5.0	4.7	5.4
66.0	3.1	3.1	3.3	3.5	3.5	4.1	4.2	4.5	4.5
70.0	2.4	2.4	2.5	2.8	2.8	3.3	3.4	3.8	3.7
74.0	1.8/73.3	1.8	1.8	2.1	2.1	2.5	2.7	3.0	3.0
78.0		1.8/74.1	1.8/74.8	1.8/76.3	1.8/77.6	1.9	2.1	2.3	2.3
82.0						1.8/78.6	1.8/80.0	1.8/81.6	1.8
84.3									1.8
No. of part line	2	1	1	2	1	1	1	1	1

Boom length(m)	73.20									
Jib length(m)	12.20			18.30			24.40		30.50	
Jib offset angle(°)	10		30	10		30	10	30	10	30
Working radius(m)										
18.3	17.7	13.5/18.5								
20.0	17.4	13.5	13.0/21.9	16.9/21.0	13.5/21.3					
22.0	17.0	13.5	12.8	16.7	13.5		13.5/23.7			
24.0	16.6	13.5	12.5	16.3	13.5		13.5		9.0/25.8	
26.0	16.2	13.5	12.2	16.0	13.5	9.0	13.5		9.0	
28.0	15.7	13.5	11.9	15.6	13.5	8.8	13.5	7.0/29.9	8.8	
30.0	15.3	13.5	11.6	15.2	13.5	8.6	13.5	6.8	8.6	
32.0	14.9	13.5	11.4	14.7	13.5	8.4	13.5	6.6	8.4	5.3/33.4
34.0	14.5	13.5	11.2	14.3	13.5	8.2	13.5	6.4	8.2	5.2
36.0	13.6	13.5	11.0	14.0	13.5	8.0	13.5	6.2	8.0	5.1
38.0	12.4	12.4	10.8	13.0	13.0	7.8	13.3	6.0	7.8	5.0
40.0	11.3	11.3	10.6	11.9	11.9	7.6	12.5	5.8	7.7	4.9
42.0	10.3	10.3	10.4	10.9	10.9	7.4	11.5	5.7	7.5	4.8
44.0	9.5	9.5	10.1	10.0	10.0	7.2	10.6	5.6	7.4	4.7
46.0	8.6	8.6	9.1	9.1	9.1	7.0	9.8	5.5	7.2	4.6
48.0	7.8	7.8	8.3	8.3	8.3	6.8	9.0	5.4	7.1	4.5
50.0	7.0	7.0	7.5	7.6	7.6	6.6	8.4	5.3	7.0	4.4
54.0	5.7	5.7	6.1	6.2	6.2	6.2	7.0	5.1	6.7	4.2
58.0	4.6	4.6	4.9	5.1	5.1	5.9	5.8	4.9	6.1	4.0
62.0	3.6	3.6	3.9	4.1	4.1	4.8	4.8	4.7	5.1	3.8
66.0	2.8	2.8	3.0	3.2	3.2	3.9	3.9	4.4	4.2	3.6
70.0	2.1	2.1	2.2	2.5	2.5	3.0	3.1	3.5	3.4	3.4
74.0	1.8/71.7	1.8/73.1	1.8	1.8	1.8	2.3	2.4	2.8	2.7	3.2
78.0						1.8/77.1	1.8	2.1	2.1	2.5
82.0								1.8/80.0	1.8/80.0	1.9
82.8										1.8
No. of part line	2	1	1	2	1	1	1	1	1	1

Notes — Fly jib capacities







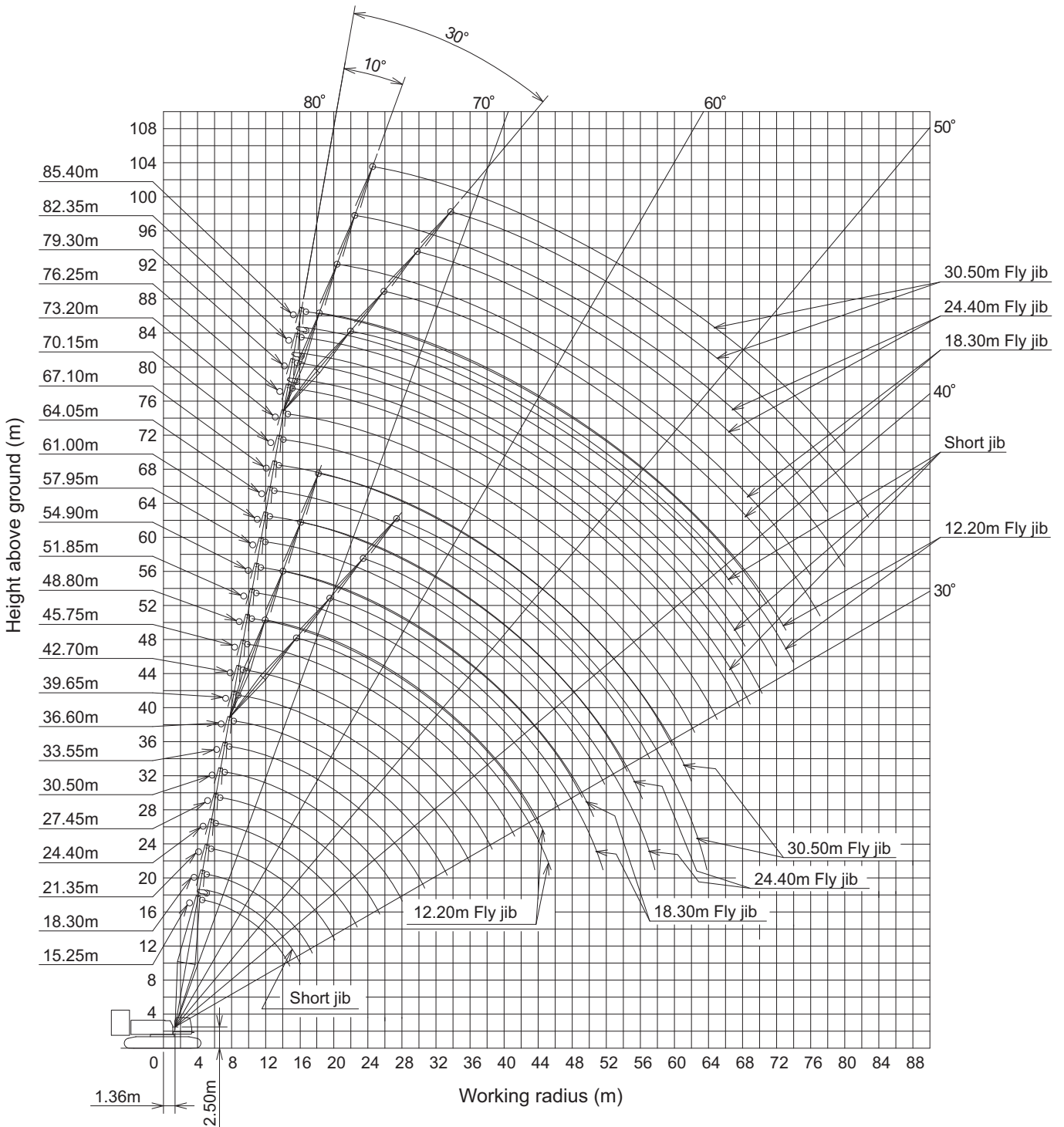
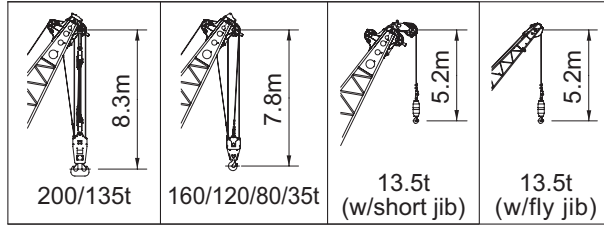





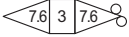
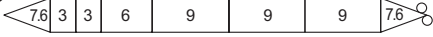
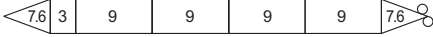
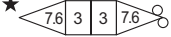

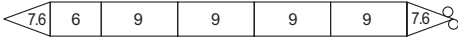
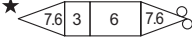
- Capacities included in these charts are the maximum allowable, and are based on machine standing level on firm supporting surface under ideal job conditions.
- Capacities are in metric tons, and are rated in accordance with European EN13000 Standards in terms of machine stability and structural strength limitations; the figures surrounded by bold lines are based on factors other than those which would cause a tipping condition.
- Capacities are based on freely suspended loads and make no allowance for such factors as the effect of wind, sudden stopping of loads, supporting surface conditions, and operating speeds. Operator must reduce load ratings to take such conditions into account. Deduction from rated capacities must be made for weight of hook block, weighted ball/hook, sling, spreader bar, or other suspended gear.
Hook block weight is as follows:
35t 0.9ton 13.5t 0.6ton
- All capacities are rated for 360° slewing.
- Least stable rated condition is over the side.
- An 80.6ton counterweight and 27.6ton lower weight are required for all capacities on these charts.
- Attachment must be erected and lowered over the ends of the crawler mounting.
- Maximum fly jib length permitted — 30.50m.
Maximum boom plus fly jib combination length permitted — 73.20m+30.50m.
- Capacities when handling load off main boom head sheaves in case of mounting fly jib on top of boom are detailed; if required, please consult us or nearest distributor.

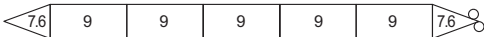
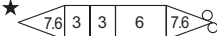
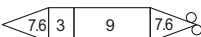
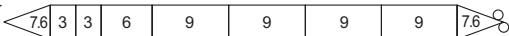
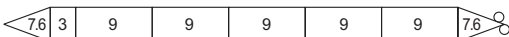
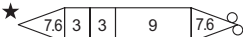
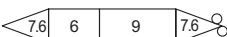
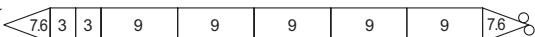
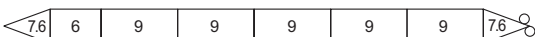
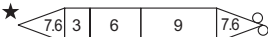
Liftcrane Working Ranges

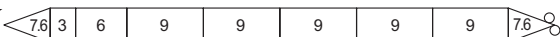
Hook lift allowance height:

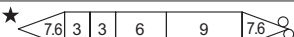

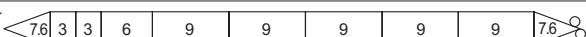
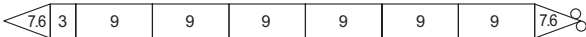
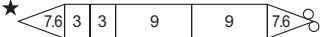
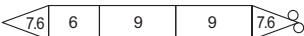
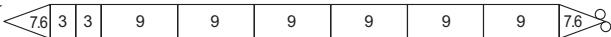
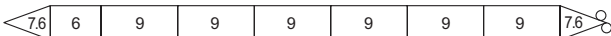
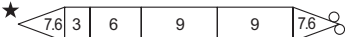
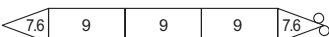
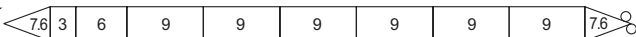
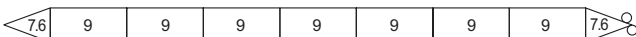
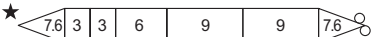
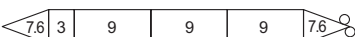
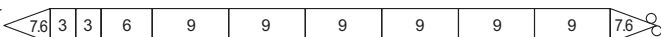
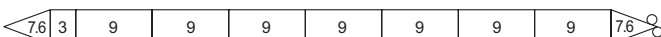
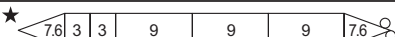
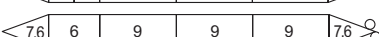
Boom Combination Diagram

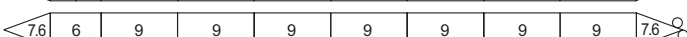
Boom length (m)	Boom combination	Boom length (m)	Boom combination
15.25		51.85	★  
18.30		54.90	★  
21.35	★  	57.95	★  
24.40	★  	61.00	★  
27.45	★  	64.05	★  
30.50	★  	67.10	★  
33.55	★  	70.15	★  
36.60	★  	73.20	★  
39.65	★  	76.25	★  
42.70	★  	79.30	★  
45.75	★  	82.35	★  
48.80	★  	85.40	★  

Note: 1. The meanings of figures and symbols shown above are as follows:

 : 7.62m base section

 : 3.05m boom extension

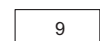
 : 9.15m boom extension

 : 7.62m tapered top section

 : 6.10m boom extension

An asterisk star mark (★) indicates manufacturer's recommended boom configuration in a consideration that it is able to set boom length in the pitch of 3.05 meters from its maximum length; other boom configuration with no asterisk mark (★) is not able to do such an arrangement of boom length.

Clamshell 3.0m³ over

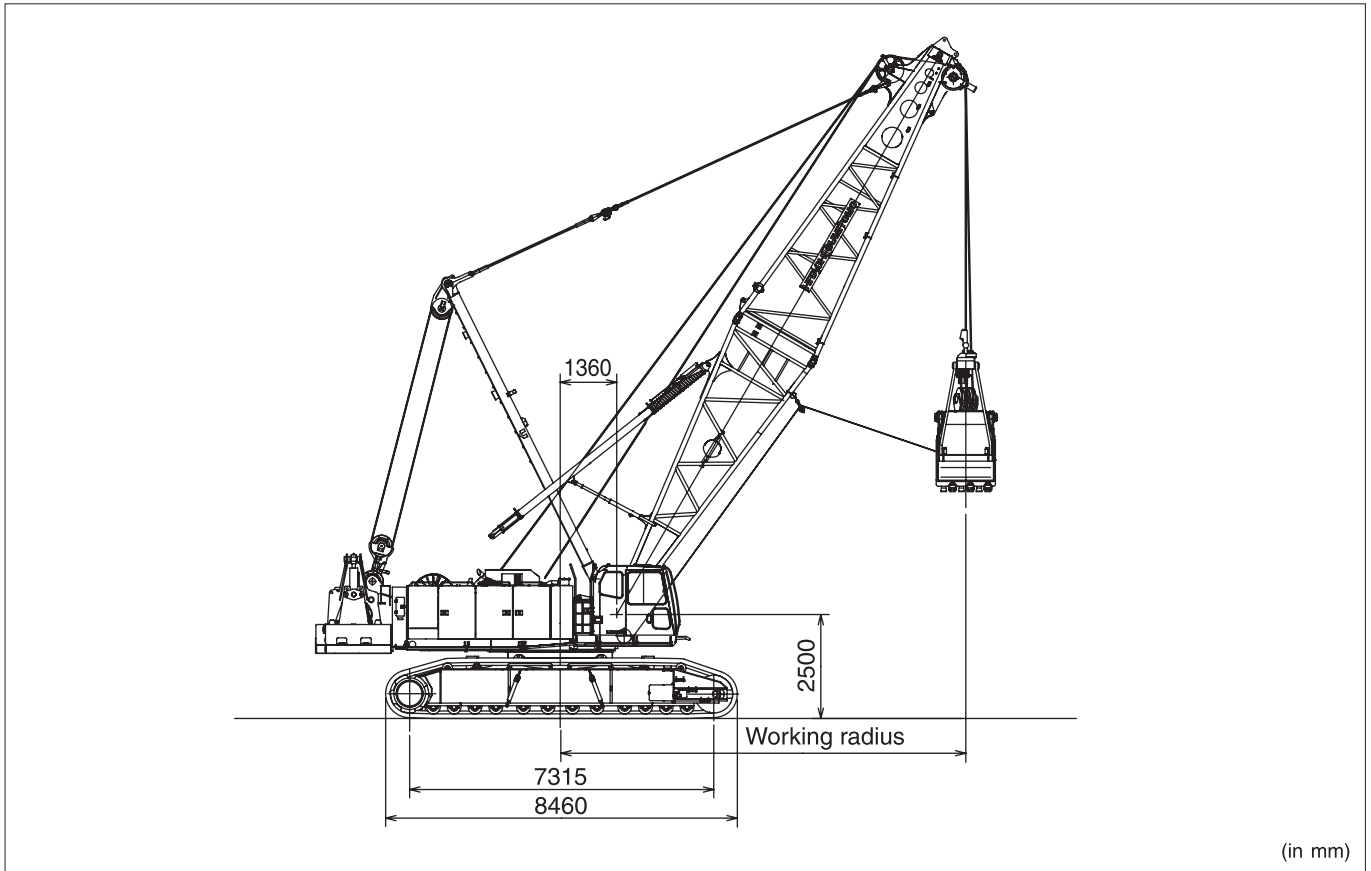

■ CLAMSHELL RATINGS:

29.1t Upper counterweight and 27.6t Lower weight (See note 5)

Boom length (m)	15.25	18.30	21.35	24.40	27.45
Working radius (m)	12.5	12.5/9.9	12.5/11.2	12.5/12.5	12.5/13.8
8.6	12.5				
9.0	12.5	12.5/9.9			
10.0	12.5	12.5	12.5/11.2		
12.0	12.5	12.5	12.5	12.5/12.5	12.5/13.8
14.0	12.5	12.5	12.5	12.5	12.5
16.0	12.5/14.4	12.5	12.5	12.5	12.5
18.0		12.5/16.9	12.5	12.5	12.5
20.0			12.5/19.4	12.5	12.5
22.0				12.5/21.9	12.5
24.0					12.5
26.0					12.5/24.4

(in metric tons)

Notes:

1. Max. clamshell rating is 12.5t.
2. Mass of bucket plus load should not exceed clamshell ratings shown above. Following data are for a general digging application bucket.

Bucket capacity	3.0m ³
Bucket mass	6.5t

3. Boom length shall not exceed 27.45m.
4. Apparent specific gravity of lifting material:
 Earth1.7~1.8t/m³
 Gravel1.8~2.0t/m³
5. Upper counterweight must be reduced greatly and strictly composed as follows as an absolute condition.
 Upper counterweight composition for clamshell operation:
 Total 29.1ton = 17.8ton base weight + one piece of "R1" (5.5ton)
 + one piece of "L1" (5.8ton).
 Lower weight:
 Total 27.6ton weight must be composed for clamshell operation.
6. Max. digging depth below ground shall be 36m.

■ WORKING MASS & GROUND CONTACT PRESSURE:

Shoe width	Mass	Pressure
1120mm	148.2t	88.7kPa <0.91kg/cm ² >

Note: Working mass shown above is with 15.25m boom, 29.1t upper counterweight, 27.6t lower weight, hydraulic tagline winder and 3.0m³/6.5t clamshell bucket.

■ BUCKET DIMENSIONS:

(in m)

		3.0m ³
A	Bucket overall height (opened)	4.55
B	Bucket overall height (closed)	3.55
C	Bucket opening width	3.50

Notes:

1. 3.0m³ bucket is for general excavating purpose.
2. Other type of bucket is also available.

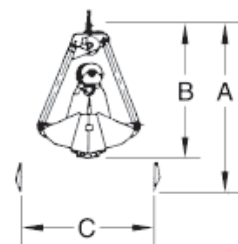

General Dimensions

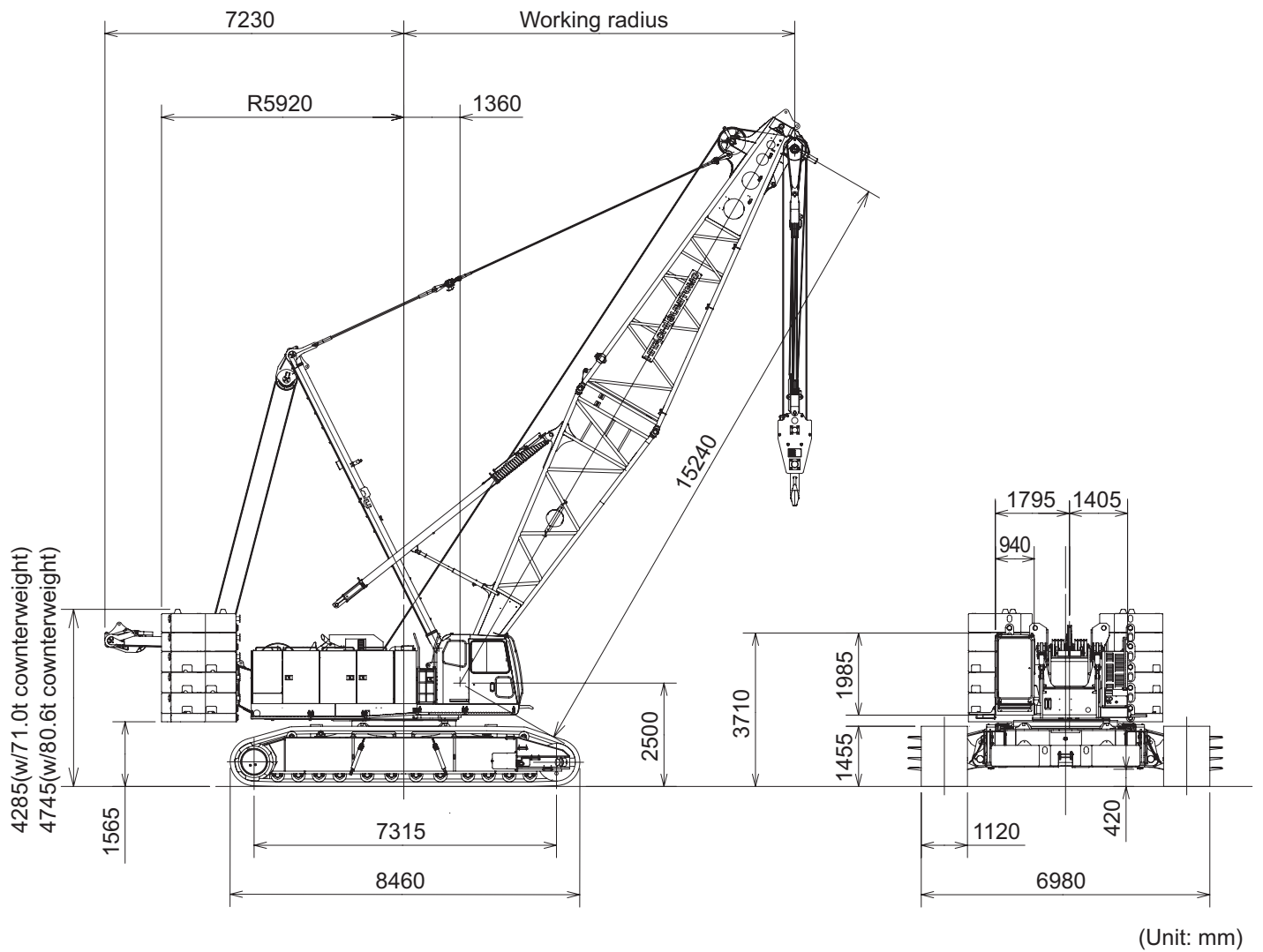

Note: The above general arrangement is under liftcrane application with 15.25m basic boom, 71.0ton upper counterweight, 27.6ton lower weight, and optional 200t hook block.

Tower Jib Specification

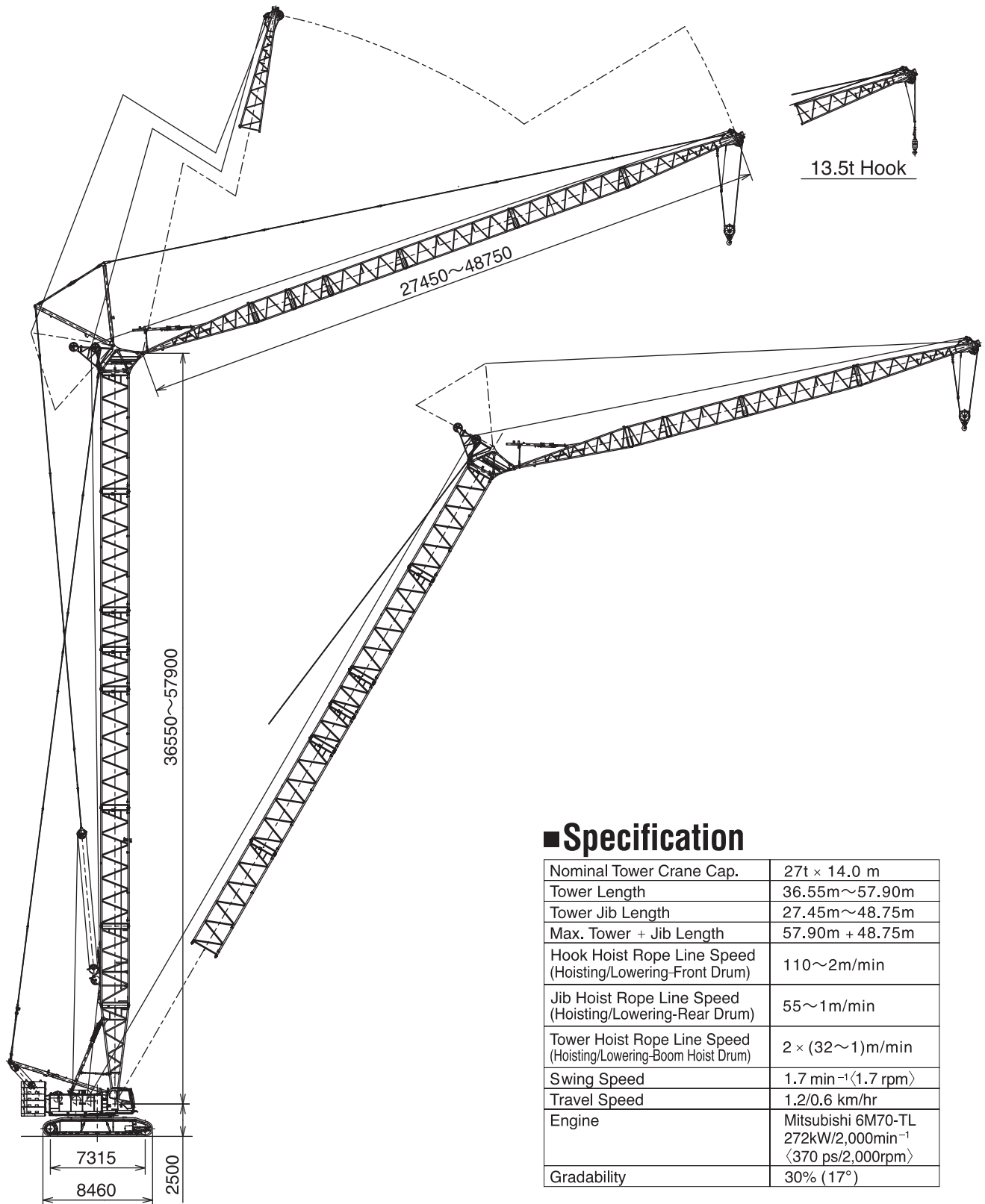

■ Specification

Nominal Tower Crane Cap.	27t × 14.0 m
Tower Length	36.55m~57.90m
Tower Jib Length	27.45m~48.75m
Max. Tower + Jib Length	57.90m + 48.75m
Hook Hoist Rope Line Speed (Hoisting/Lowering-Front Drum)	110~2m/min
Jib Hoist Rope Line Speed (Hoisting/Lowering-Rear Drum)	55~1m/min
Tower Hoist Rope Line Speed (Hoisting/Lowering-Boom Hoist Drum)	2 × (32~1)m/min
Swing Speed	1.7 min ⁻¹ (1.7 rpm)
Travel Speed	1.2/0.6 km/hr
Engine	Mitsubishi 6M70-TL 272kW/2,000min ⁻¹ (370 ps/2,000rpm)
Gradability	30% (17°)

Front-end Attachment

TOWER BOOM:

- Lattice construction, round tubular main chords, alloy, hi-ten steel, with bracing of round steel tubing.
- Tower boom connections In-line pin connections at 2.10m deep by 2.10m wide.
- Special tower boom extensions (1) 6.10m long, lattice construction; pins tower jib bail assembly on upper part, and just pinned next to 7.62m base section. Available to use as liftcrane boom extension.
- (2) 9.15m long, lattice construction; provided with tower jib hoist bridle guide rails, and pinned next to 9.0m extension as 4th section in the configuration. Available to use as liftcrane boom extension.
- Tower boom extensions Available in length of 3.05m, 6.10m, 9.15m with tower boom/tower jib hoist pendants, and to use as liftcrane boom extension.
- Tower head section 1.50m long, lattice construction; pinned on top of tower boom. Pins tower jib and fan-shaped post, and provides one guide sheave for hoist cable and two guide rollers for tower jib hoist pendant ropes.
- Tower boom length 36.55m to 57.90m; the configuration of a 57.90m tower boom as maximum is as under as recommended:
(1) 7.62m base section + (2) 6.10m special ext. + (3) 9.0m ext. + (4) 9.0m special ext. + (5) 3.0m ext. x 2 pcs. + (6) 9.0m ext. x 2 pcs. + (7) 1.50m head section.
- Tower boom luffing angle 90° thru 60° (according to tower boom/jib combination).

Notes:

1. Base section of 7.62m long and boom extensions of 3.05m, 6.10m, 9.15m long as necessary to complete liftcrane boom attachment are available from those of towercrane boom attachment.
2. In a case of converting towercrane boom attachment of 57.90m as max. as shown above to liftcrane boom attachment of 85.4m as maximum as available, three items of one 6.10m boom extension, two 9.15m boom extensions and 7.62m tapered crane top section are only additionally required.

TOWER JIB:

- Lattice construction, round tubular main chords, alloy hi-ten steel, with bracing of round steel tubing.
- Tower jib connections In-line pin connections at 1.55m deep by 1.55m wide.
- Basic tower jib Three-piece, 27.45m basic length; 9.15m base section, one 3.05m extension one 6.10m extensic and 9.15m tower jib top section.
- Tower jib top head machinery Single head and one guide sheaves mounted on anti-friction bearings.
- Tower jib extensions Available in 3.05m, 6.10m and 9.15m lengths with pendants.
- Maximum tower jib length 48.75m tower jib as maximum consists of (1) 9.15m base section + (2) 3.05m ext. x 2 + (3) 6.10m ext. + (4) 9.15m ext. x 2 pcs. + (5) 9.15m top section.
- Tower jib angle Available from 15° thru 75° to ground (according to tower boom/jib combination)

FAN-SHAPED POST:

All-welded construction; pinned to tower head section. Serves as mechanical connection for tower jib hoisting and lowering motions.

TOWER JIB BAIL AND BRIDLE:

All-welded construction; provided with larger sheaves of a 22.8 D/d ratio on both bail and bridle for an 8-part tower jib hoist rope reeving. Bail pinned to an 6.10m special tower boom extension, and bridle suspended between an 8-part tower jib hoist rope and pendant ropes connecting to tower post.

HOOK BLOCKS:

To be selected from 27ton and 13.5ton hook blocks.

DRUM DATA:

See DRUM DATA mentioned into page 8.

HOIST REEVING:

No. of part line	Towercrane hoist	
		2
Max. load (ton)	27.0	13.5

CABLES:

See CABLES mentioned into page 8.

WORKING WEIGHT:

Approx. 215.0ton with 57.90m tower boom, 48.75m tower jib, 80.6ton counterweight, 27.6ton lower weight, 1120mm wide track shoes and 27t hook block.

GROUND CONTACT PRESSURE:

89kPa <0.91kg/cm²> under an 215.0ton working weight mentioned above.

Tower Jib Capacities 27metric tons

■ w/36.55m Tower

(ton)

Jib length(m) Tower angle(°) Working radius(m)	27.45								30.50							
	90		80		70		60		90		80		70		60	
10.8	27.0	13.5/11.3							26.5/11.6							
12.0	27.0	13.5							26.5	13.5/12.1						
14.0	27.0	13.5							26.0	13.5						
16.0	26.0	13.5							25.0	13.5						
18.0	25.0	13.5							24.8	13.5						
20.0	24.3	13.5	25.0/21.5						24.0	13.5						
22.0	22.2	13.5	25.0	13.5/22.1					22.0	13.5	24.5/22.7	13.5/23.4				
24.0	20.4	13.5	24.5	13.5					20.1	13.5	24.0	13.5				
26.0	18.6	13.5	23.6	13.5					18.7	13.5	23.1	13.5				
28.0	15.9	13.5	21.3	13.5					16.9	13.5	20.8	13.5				
30.0	12.4/29.3	12.4	19.6	13.5	20.1/31.5				14.7	13.5	19.0	13.5				
32.0		11.7/30.3	18.3	13.5	19.7	13.5/32.3			11.7	11.7	17.7	13.5	19.0/33.3			
34.0			17.4	13.5	18.5	13.5			10.8/32.3	10.2/33.3	16.6	13.5	18.4	13.5		
36.0			15.1/35.7	13.5	17.5	13.5					15.9	13.5	17.4	13.5		
38.0				13.5/36.7	16.4	13.5					13.9	13.5	16.3	13.5		
40.0					15.4	13.5	13.5/40.7	13.2/41.5			13.2/38.6	12.6/39.6	15.2	13.5		
42.0					14.6/41.7	13.5	12.9	12.9					14.3	13.5	12.4/42.8	12.1/43.7
44.0						13.5/42.7	12.2	12.2					13.4	13.4	12.0	12.0
46.0							11.5	11.5					13.1/44.7	12.8/45.7	11.3	11.3
48.0							11.0/47.3	10.9							10.6	10.6
50.0								10.8/48.3							10.0	10.0
52.0															9.9/50.3	9.7/51.3
No. of part line	2	1	2	1	2	1	2	1	2	1	2	1	2	1	2	1

■ w/39.60m Tower

Jib length(m) Tower angle(°) Working radius(m)	27.45								30.50							
	90		80		70		60		90		80		70		60	
10.8	27.0	13.5/11.3							26.5/11.6							
12.0	27.0	13.5							26.5	13.5/12.1						
14.0	27.0	13.5							26.0	13.5						
16.0	26.0	13.5							25.0	13.5						
18.0	25.0	13.5							24.8	13.5						
20.0	24.3	13.5							24.0	13.5						
22.0	22.2	13.5	25.0	13.5/22.6					22.0	13.5	24.0/23.3	13.5/23.9				
24.0	20.4	13.5	24.5	13.5					20.1	13.5	24.0	13.5				
26.0	18.6	13.5	24.0	13.5					18.6	13.5	23.5	13.5				
28.0	15.9	13.5	21.9	13.5					16.9	13.5	21.3	13.5				
30.0	12.6/29.3	12.6	20.0	13.5					14.7	13.5	19.4	13.5				
32.0		11.9/30.3	18.6	13.5	19.5/32.5	13.5/33.3			11.9	11.9	18.0	13.5				
34.0			17.6	13.5	18.5	13.5			11.0/32.3	10.4/33.3	16.9	13.5	18.1/34.3	13.5/35.0		
36.0			15.4	13.5	17.2	13.5					16.0	13.5	17.0	13.5		
38.0			15.1/36.2	13.5/37.2	16.1	13.5					14.5	13.5	15.9	13.5		
40.0					15.1	13.5					13.3/39.1	12.7	14.9	13.5		
42.0					14.1	13.5	12.4/42.2	12.1/43.0				12.6/40.1	14.0	13.5		
44.0					13.8/42.8	13.4/43.8	11.7	11.7					13.1	13.1	11.4/44.3	11.2/45.2
46.0							11.0	11.0					12.4/45.7	12.4	10.8	10.8
48.0							10.4	10.4						12.2/46.7	10.2	10.2
50.0							10.1/48.9	9.9/49.9							9.6	9.6
52.0															9.1/51.8	9.1
54.0																9.0/52.8
No. of part line	2	1	2	1	2	1	2	1	2	1	2	1	2	1	2	1

Jib length(m) Tower angle(°) Working radius(m)	33.50							
	90		80		70		60	
12.4	24.7	13.5/12.9						
14.0	24.5	13.5						
16.0	24.3	13.5						
18.0	24.1	13.5						
20.0	23.5	13.5						
22.0	21.9	13.5						
24.0	20.0	13.5	23.5/24.6	13.5/25.2				
26.0	18.5	13.5	23.0	13.5				
28.0	17.3	13.5	21.2	13.5				
30.0	15.8	13.5	19.3	13.5				
32.0	13.9	13.5	17.7	13.5				
34.0	12.2	12.2	16.6	13.5				
36.0	10.2/35.2	10.2	15.6	13.5	17.2	13.5/36.8		
38.0		9.7/36.2	14.9	13.5	16.1	13.5		
40.0			13.8	13.5	15.1	13.5		
42.0			12.0	12.0	14.2	13.5		
44.0			11.9/42.1	11.4/43.1	13.3	13.3		
46.0					12.6	12.6	10.9/46.5	10.7/47.3
48.0					11.9	11.9	10.4	10.4
50.0					11.7/48.6	11.4/49.7	9.8	9.8
52.0							9.3	9.3
54.0							8.8	8.8
56.0							8.7/54.7	8.5/55.8
No. of part line	2	1	2	1	2	1	2	1

■ w/42.65m Tower

(ton)

Jib length(m) Tower angle(°) Working radius(m)	27.45								30.50							
	90		80		70		60		90		80		70		60	
10.8	27.0	13.5/11.3							26.5/11.6							
12.0	27.0	13.5							26.5	13.5/12.1						
14.0	27.0	13.5							26.0	13.5						
16.0	26.0	13.5							25.0	13.5						
18.0	25.0	13.5							24.8	13.5						
20.0	24.3	13.5							24.0	13.5						
22.0	22.2	13.5	25.0/22.5	13.5/23.1					21.9	13.5	24.0/23.8					
24.0	20.4	13.5	24.5	13.5					20.1	13.5	24.0	13.5/24.4				
26.0	18.5	13.5	24.0	13.5					18.6	13.5	23.5	13.5				
28.0	15.8	13.5	22.4	13.5					16.9	13.5	21.9	13.5				
30.0	12.8/29.3	12.8	20.4	13.5					14.7	13.5	19.9	13.5				
32.0		12.0/30.3	18.9	13.5	18.4/33.6				12.1	12.1	18.3	13.5				
34.0			17.8	13.5	18.2	13.5/34.3			11.1/32.3	10.5/33.3	17.1	13.5	17.1/35.3			
36.0			16.1	13.5	16.9	13.5					16.2	13.5	16.7	13.5/36.1		
38.0			15.1/36.7	13.5/37.7	15.8	13.5					15.0	13.5	15.6	13.5		
40.0					14.8	13.5					13.2/39.7	13.2	14.6	13.5		
42.0					13.8	13.5	11.4/43.7				12.5/40.7	13.7	13.5			
44.0					13.1/43.8	13.1	11.3	11.2/44.5				12.8	12.8	10.5/45.9		
46.0						12.8/44.8	10.6	10.6				12.1	12.1	10.4	10.3/46.7	
48.0							10.0	10.0				11.8/46.7	11.5/47.8	9.8	9.8	
50.0							9.5	9.5						8.8	8.8	
52.0							9.3/50.4	9.1/51.4						8.4/53.3	8.3	
54.0															8.3	
56.0															8.3/54.3	
No. of part line	2	1	2	1	2	1	2	1	2	1	2	1	2	1	2	

Jib length(m) Tower angle(°) Working radius(m)	33.50								36.55							
	90		80		70		60		90		80		70		60	
12.4	24.7	13.5/12.9							22.7/13.2	13.5/13.7						
14.0	24.5	13.5							22.6	13.5						
16.0	24.3	13.5							22.4	13.5						
18.0	24.1	13.5							22.2	13.5						
20.0	23.5	13.5							22.0	13.5						
22.0	21.9	13.5							21.5	13.5						
24.0	20.0	13.5	23.5/25.1	13.5/25.7					19.6	13.5						
26.0	18.5	13.5	23.0	13.5					18.1	13.5	23.5/26.4	13.5/27.0				
28.0	17.3	13.5	21.8	13.5					16.8	13.5	21.4	13.5				
30.0	15.7	13.5	19.7	13.5					15.8	13.5	19.3	13.5				
32.0	13.9	13.5	18.1	13.5					14.4	13.5	17.6	13.5				
34.0	12.2	12.2	16.8	13.5					12.9	12.9	16.3	13.5				
36.0	10.3/35.2	10.3	15.8	13.5	16.2/37.1	13.5/37.8			11.5	11.5	15.3	13.5				
38.0		9.8/36.2	15.1	13.5	15.8	13.5			9.6	9.6	14.5	13.5	15.2/38.8	13.5/39.6		
40.0			14.2	13.5	14.8	13.5			9.2/38.2	8.7/39.2	13.8	13.5	14.6	13.5		
42.0			12.5	12.5	13.9	13.5					13.2	13.1	13.7	13.5		
44.0			12.0/42.6	11.4/43.6	13.1	13.1					11.8	11.8	12.9	12.9		
46.0					12.3	12.3					10.7/45.5	10.6	12.2	12.2		
48.0					11.6	11.6	10.0	9.8/48.9			10.1/46.6	11.5	11.5			
50.0					11.1/49.7	11.1	9.5	9.5				10.9	10.9	9.3/50.2	9.1/51.0	
52.0						10.9/50.7	9.0	9.0				10.3	10.3	8.8	8.8	
54.0							8.5	8.5				10.2/52.6	10.0/53.6	8.4	8.4	
56.0							8.0	8.0						7.9	7.9	
58.0							8.0/56.3	7.8/57.3						7.5	7.5	
60.0														7.3/59.2	7.2	
62.0															7.2/60.2	
No. of part line	2	1	2	1	2	1	2	1	2	1	2	1	2	1	2	

■ w/45.70m Tower

(ton)

Jib length(m) Tower angle(°) Working radius(m)	27.45								30.50							
	90		80		70		60		90		80		70		60	
10.8	27.0	13.5/11.3							26.5/11.6							
12.0	27.0	13.5							26.5	13.5/12.1						
14.0	27.0	13.5							26.0	13.5						
16.0	26.0	13.5							25.0	13.5						
18.0	25.0	13.5							24.8	13.5						
20.0	24.3	13.5							24.0	13.5						
22.0	22.2	13.5	25.0/23.0	13.5/23.7					21.9	13.5						
24.0	20.4	13.5	24.5	13.5					20.0	13.5	24.0/24.3	13.5/25.0				
26.0	18.5	13.5	24.0	13.5					18.6	13.5	23.5	13.5				
28.0	15.8	13.5	22.7	13.5					16.9	13.5	22.5	13.5				
30.0	12.9/29.3	12.9	20.9	13.5					14.7	13.5	20.3	13.5				
32.0		12.1/30.3	19.3	13.5					12.2	12.2	18.7	13.5				
34.0			18.1	13.5	17.3/34.6	13.5/35.4			11.2/32.3	10.6/33.3	17.4	13.5				
36.0			16.8	13.5	16.4	13.5					16.4	13.5	15.9/36.4	13.5/37.1		
38.0			15.2/37.2	13.5	15.3	13.5					15.6	13.5	15.1	13.5		
40.0				13.5/38.3	14.4	13.5					13.4	13.4	14.2	13.5		
42.0					13.5	13.5					13.2/40.2	12.5/41.2	13.3	13.3		
44.0					12.6	12.6	10.4/45.2						12.5	12.5		
46.0					12.3/44.8	12.0/45.9	10.1	10.1/46.1					11.7	11.7	9.5/47.4	
48.0							9.5	9.5					11.1/47.8	11.1	9.3	
50.0							9.0	9.0					10.9/48.8	8.8	9.3/48.2	
52.0							8.5/51.9	8.5						8.3	8.3	
54.0								8.3/52.9						7.8	7.8	
56.0														7.6/54.9	7.5/55.9	
No. of part line	2	1	2	1	2	1	2	1	2	1	2	1	2	1	2	

Jib length(m) Tower angle(°) Working radius(m)	33.50								36.55							
	90		80		70		60		90		80		70		60	
12.4	24.7	13.5/12.9							22.7/13.2	13.5/13.7						
14.0	24.5	13.5							22.6	13.5						
16.0	24.3	13.5							22.4	13.5						
18.0	24.1	13.5							22.2	13.5						
20.0	23.5	13.5							22.0	13.5						
22.0	21.9	13.5							21.5	13.5						
24.0	20.0	13.5	23.0/25.6						19.6	13.5						
26.0	18.4	13.5	23.0	13.5/26.2					18.0	13.5	22.5/26.9	13.5/27.5				
28.0	17.2	13.5	22.4	13.5					16.8	13.5	22.0	13.5				
30.0	15.7	13.5	20.2	13.5					15.8	13.5	19.7	13.5				
32.0	13.9	13.5	18.5	13.5					14.4	13.5	18.0	13.5				
34.0	12.2	12.2	17.1	13.5					12.9	12.9	16.6	13.5				
36.0	10.4/35.2	10.4	16.1	13.5					11.4	11.4	15.5	13.5				
38.0		9.9/36.2	15.2	13.5	15.3/38.1	13.5/38.9			9.7	9.7	14.6	13.5	14.2/39.9			
40.0			14.6	13.5	14.3	13.5			9.3/38.2	8.8/39.2	13.9	13.5	14.2	13.5/40.6		
42.0			12.9	12.9	13.5	13.5					13.4	13.2	13.3	13.3		
44.0			12.0/43.1	11.5	12.7	12.7					12.1	12.1	12.5	12.5		
46.0				11.4/44.1	12.0	12.0					10.7	10.7	11.8	11.8		
48.0					11.3	11.3	9.1/49.5				10.6/46.1	10.1/47.1	11.2	11.2		
50.0					10.7	10.7	9.0	8.9/50.4					10.6	10.6	8.4/51.7	
52.0					10.5/50.7	10.3/51.7	8.5	8.5					10.0	10.0	8.4	
54.0							8.0	8.0					9.6/53.7	9.6	7.9	
56.0							7.6	7.6						9.4/54.7	7.5	
58.0							7.3/57.8	7.3							7.1	
60.0								7.1/58.8							6.7	
62.0															6.6/60.7	
64.0															6.5/61.8	
No. of part line	2	1	2	1	2	1	2	1	2	1	2	1	2	1	2	

Jib length(m) Tower angle(°) Working radius(m)	39.60							
	90		80		70		60	
13.9	21.0							
14.0	20.9	13.5/14.4						
16.0	20.8	13.5						
18.0	20.6	13.5						
20.0	20.4	13.5						
22.0	20.2	13.5						
24.0	19.1	13.5						
26.0	17.6	13.5						
28.0	16.3	13.5	21.3/28.2	13.5/28.8				
30.0	15.3	13.5	19.3	13.5				
32.0	14.5	13.5	17.5	13.5				
34.0	13.2	13.2	16.1	13.5				
36.0	11.9	11.9	15.0	13.5				
38.0	10.7	10.7	14.1	13.5				
40.0	9.5	9.5	13.3	13.3	13.3/41.6			
42.0	8.4/41.1	8.2	12.7	12.7	13.1	13.0/42.4		
44.0		8.0/42.1	12.2	12.2	12.3	12.3		
46.0			11.3	11.3	11.6	11.6		
48.0			10.1	10.1	11.0	11.0		
50.0			9.5/49.0	9.1	10.4	10.4		
52.0					9.8	9.8	7.7/53.8	
54.0					9.3	9.3	7.7	7.6/54.7
56.0					8.9	8.9	7.3	7.3
58.0					8.7/56.6	8.5/57.6	6.9	6.9
60.0							6.6	6.6
62.0							6.2	6.2
64.0							5.9/63.7	5.9
66.0								5.8/64.7
No. of part line	2	1	2	1	2	1	2	1

w/48.75m Tower

(ton)

Jib length(m) Tower angle(°) Working radius(m)	27.45								30.50							
	90		80		70		60		90		80		70		60	
10.8	27.0	13.5/11.3							26.5/11.6							
12.0	27.0	13.5							26.5	13.5/12.1						
14.0	27.0	13.5							26.0	13.5						
16.0	26.0	13.5							25.0	13.5						
18.0	25.0	13.5							24.8	13.5						
20.0	24.3	13.5							24.0	13.5						
22.0	22.2	13.5	24.5/23.6						21.9	13.5						
24.0	20.4	13.5	24.5	13.5/24.2					20.0	13.5	24.0/24.9	13.5/25.5				
26.0	18.5	13.5	24.0	13.5					18.6	13.5	23.5	13.5				
28.0	15.8	13.5	22.7	13.5					16.8	13.5	22.7	13.5				
30.0	13.0/29.3	13.0	21.1	13.5					14.7	13.5	20.8	13.5				
32.0		12.2/30.3	19.6	13.5					12.3	12.3	19.0	13.5				
34.0			18.3	13.5	16.0/35.7				11.3/32.3	10.7/33.3	17.7	13.5				
36.0			17.4	13.5	15.9	13.5/36.4					16.6	13.5	15.0/37.4			
38.0			15.0/37.8	13.5	15.0	13.5					15.8	13.5	14.7	13.5/38.2		
40.0				13.5/38.8	14.0	13.5					14.0	13.5	13.8	13.5		
42.0					13.1	13.1					13.2/40.7	12.6/41.7	12.9	12.9		
44.0					12.3	12.3							12.2	12.2		
46.0					11.6/45.9	11.6	9.4/46.8	9.2/47.6					11.4	11.4		
48.0						11.4/46.9	9.1	9.1					10.8	10.8	8.6/48.9	
50.0							8.6	8.6					10.5/48.8	10.3/49.8	8.4	
52.0							8.1	8.1							7.9	
54.0							7.8/53.4	7.7							7.5	
56.0								7.6/54.4							7.0	
58.0															7.0/56.4	
58.0															6.8/57.4	
No. of part line	2	1	2	1	2	1	2	1	2	1	2	1	2	1	2	

Jib length(m) Tower angle(°) Working radius(m)	33.50								36.55							
	90		80		70		60		90		80		70		60	
12.4	24.7	13.5/12.9							22.7/13.2	13.5/13.7						
14.0	24.5	13.5							22.6	13.5						
16.0	24.3	13.5							22.4	13.5						
18.0	24.1	13.5							22.2	13.5						
20.0	23.5	13.5							22.0	13.5						
22.0	21.8	13.5							21.5	13.5						
24.0	19.9	13.5							19.5	13.5						
26.0	18.4	13.5	23.5/26.1	13.5/26.8					18.0	13.5	23.1/27.4					
28.0	17.2	13.5	22.7	13.5					16.8	13.5	22.7	13.5/28.1				
30.0	15.7	13.5	20.7	13.5					15.8	13.5	20.3	13.5				
32.0	13.9	13.5	18.9	13.5					14.4	13.5	18.4	13.5				
34.0	12.1	12.1	17.4	13.5					12.8	12.8	16.9	13.5				
36.0	10.5/35.2	10.5	16.3	13.5					11.4	11.4	15.8	13.5				
38.0		10.0/36.2	15.4	13.5	14.3/39.2	13.5/39.9			9.8	9.8	14.8	13.5				
40.0			14.7	13.5	14.0	13.5			9.3/38.2	8.9/39.2	14.1	13.5	13.4/40.9	13.2/41.7		
42.0			13.4	13.4	13.1	13.1					13.5	13.4	13.0	13.0		
44.0			11.9/43.7	11.9	12.4	12.4					12.5	12.5	12.2	12.2		
46.0				11.3/44.7	11.6	11.6					11.1	11.1	11.5	11.5		
48.0					11.0	11.0					10.6/46.6	10.2/47.6	10.9	10.9		
50.0					10.4	10.4	8.3/51.1	8.1/51.9					10.3	10.3		
52.0					9.9/51.8	9.9	8.1	8.1					9.7	9.7	7.7/53.2	
54.0						9.7/52.8	7.7	7.7					9.2	9.2	7.5	
56.0							7.3	7.3					9.1/54.7	8.9/55.7	7.1	
58.0							6.9	6.9							6.8	
60.0							6.6/59.3	6.6							6.4	
62.0								6.5/60.3							6.1	
64.0															6.0/62.3	
64.0															5.9/63.3	
No. of part line	2	1	2	1	2	1	2	1	2	1	2	1	2	1	2	

Jib length(m) Tower angle(°) Working radius(m)	39.60								42.65							
	90		80		70		60		90		80		70		60	
13.9	21.0															
14.0	20.9	13.5/14.4							19.4/14.7	13.5/15.2						
16.0	20.8	13.5							19.3	13.5						
18.0	20.6	13.5							19.2	13.5						
20.0	20.4	13.5							19.1	13.5						
22.0	20.2	13.5							19.0	13.5						
24.0	19.1	13.5							18.7	13.5						
26.0	17.6	13.5							17.2	13.5						
28.0	16.3	13.5	21.3/28.7	13.5/29.4					15.9	13.5						
30.0	15.3	13.5	19.8	13.5					14.9	13.5	19.4	13.5/30.6				
32.0	14.5	13.5	17.9	13.5					14.0	13.5	17.5	13.5				
34.0	13.2	13.2	16.4	13.5					13.3	13.3	16.0	13.5				
36.0	11.9	11.9	15.2	13.5					12.1	12.1	14.8	13.5				
38.0	10.6	10.6	14.3	13.5					11.0	11.0	13.8	13.5				
40.0	9.5	9.5	13.5	13.5					9.9	9.9	13.0	13.0				
42.0	8.5/41.1	8.3	12.9	12.9	12.4/42.7	12.2/43.4			8.9	8.9	12.3	12.3				
44.0		8.1/42.1	12.4	12.3	12.0	12.0			7.7	7.7	11.8	11.8	11.7/44.4	11.5/45.2		
46.0			11.6	11.6	11.3	11.3			7.6/44.1	7.3/45.1	11.3	11.3	11.2	11.2		
48.0			10.4	10.4	10.7	10.7					10.8	10.8	10.5	10.5		
50.0			9.5/49.5	9.4	10.1	10.1					9.8	9.8	10.0	10.0		
52.0				9.0/50.6	9.6	9.6					8.7	8.7	9.4	9.4		
54.0					9.1	9.1	7.0/55.4				8.5/52.5	8.2/53.5	8.9	8.9		
56.0					8.6	8.6	6.9	6.9/56.2					8.5	8.5	6.5/57.5	
58.0					8.2/57.7	8.2	6.5	6.5					8.1	8.1	6.4	
60.0						8.1/58.7	6.2	6.2					7.6	7.6	6.1	
62.0							5.9	5.9					7.5/60.6	7.4/61.6	5.7	
64.0							5.6	5.6							5.5	
66.0							5.4/65.2	5.3							5.2	
68.0								5.3/66.2							4.9	
70.0															4.9/68.2	
70.0															4.8/69.2	
No. of part line	2	1	2	1	2	1	2	1	2	1	2	1	2	1	2	

■ w/51.80m Tower

(ton)

Jib length(m) Tower angle(°) Working radius(m)	27.45								30.50							
	90		80		70		60		90		80		70		60	
10.8	27.0	13.5/11.3							26.5/11.6							
12.0	27.0	13.5							26.5	13.5/12.1						
14.0	27.0	13.5							26.0	13.5						
16.0	26.0	13.5							25.0	13.5						
18.0	25.0	13.5							24.8	13.5						
20.0	24.3	13.5							24.0	13.5						
22.0	22.2	13.5							21.9	13.5						
24.0	20.4	13.5	24.5/24.1	13.5/24.7					20.0	13.5	24.0/25.4					
26.0	18.5	13.5	24.0	13.5					18.5	13.5	23.5	13.5				
28.0	15.8	13.5	22.7	13.5					16.8	13.5	22.7	13.5				
30.0	13.1/29.3	13.1	21.1	13.5					14.6	13.5	21.1	13.5				
32.0		12.3/30.3	19.8	13.5					12.4	12.4	19.5	13.5				
34.0			18.6	13.5					11.4/32.3	10.8/33.3	18.0	13.5				
36.0			17.6	13.5	15.1/36.7	13.5/37.5					16.8	13.5				
38.0			15.5	13.5	14.5	13.5					16.0	13.5	14.0/38.5	13.5/39.2		
40.0			15.1/38.3	13.5/39.3	13.7	13.5					14.5	13.5	13.4	13.4		
42.0					12.8	12.8					13.2/41.2	12.8	12.6	12.6		
44.0					12.0	12.0						12.5/42.3	11.8	11.8		
46.0					11.3	11.3							11.2	11.2		
48.0					11.0/46.9	10.8/47.9	8.6/48.3	8.5/49.1					10.5	10.5		
50.0							8.2	8.2				9.9/49.9	9.9	7.9/50.4	7.7/51.3	
52.0							7.7	7.7					9.7/50.9	7.5	7.5	
54.0							7.3	7.3						7.1	7.1	
56.0							7.1/55.0	6.9						6.7	6.7	
58.0														6.3/57.9	6.3	
60.0															6.2/58.9	
No. of part line	2	1	2	1	2	1	2	1	2	1	2	1	2	1	2	1

Jib length(m) Tower angle(°) Working radius(m)	33.50								36.55							
	90		80		70		60		90		80		70		60	
12.4	24.7	13.5/12.9							22.7/13.2	13.5/13.7						
14.0	24.5	13.5							22.6	13.5						
16.0	24.3	13.5							22.4	13.5						
18.0	24.1	13.5							22.2	13.5						
20.0	23.5	13.5							22.0	13.5						
22.0	21.8	13.5							21.4	13.5						
24.0	19.9	13.5							19.5	13.5						
26.0	18.4	13.5	23.8/26.7	13.5/27.3					18.0	13.5						
28.0	17.2	13.5	22.7	13.5					16.8	13.5	22.2	13.5/28.6				
30.0	15.7	13.5	21.1	13.5					15.8	13.5	20.8	13.5				
32.0	13.8	13.5	19.3	13.5					14.4	13.5	18.8	13.5				
34.0	12.1	12.1	17.7	13.5					12.8	12.8	17.3	13.5				
36.0	10.6/35.2	10.6	16.5	13.5					11.4	11.4	16.0	13.5				
38.0		10.1/36.2	15.6	13.5					9.9	9.9	15.0	13.5				
40.0			14.9	13.5	13.3/40.2	13.1/41.0			9.4/38.2	9.0/39.2	14.2	13.5				
42.0			13.8	13.5	12.8	12.8					13.6	13.5	12.5	12.3/42.7		
44.0			12.1	12.1	12.0	12.0					12.8	12.8	11.8	11.8		
46.0			11.9/44.2	11.4/45.2	11.3	11.3					11.4	11.4	11.2	11.2		
48.0					10.7	10.7					10.6/47.1	10.2	10.6	10.6		
50.0					10.1	10.1						10.2/48.1	10.0	10.0		
52.0					9.6	9.6	7.6/52.6	7.4/53.4					9.5	9.5		
54.0					9.4/52.8	9.2/53.8	7.3	7.3					9.0	9.0	7.0/54.7	6.9/55.6
56.0							6.9	6.9					8.6/55.8	8.6	6.7	6.7
58.0							6.5	6.5						8.4/56.8	6.4	6.4
60.0							6.2	6.2							6.1	6.1
62.0							6.0/60.8	5.9/61.9							5.8	5.8
64.0															5.5/63.8	5.5
66.0																5.4/64.8
No. of part line	2	1	2	1	2	1	2	1	2	1	2	1	2	1	2	1

Jib length(m) Tower angle(°) Working radius(m)	39.60								42.65							
	90		80		70		60		90		80		70		60	
13.9	21.0															
14.0	20.9	13.5/14.4							19.4/14.7	13.5/15.2						
16.0	20.8	13.5							19.3	13.5						
18.0	20.6	13.5							19.2	13.5						
20.0	20.4	13.5							19.1	13.5						
22.0	20.2	13.5							19.0	13.5						
24.0	19.1	13.5							18.7	13.5						
26.0	17.5	13.5							17.2	13.5						
28.0	16.3	13.5	20.6/29.3	13.5/29.9					15.9	13.5						
30.0	15.3	13.5	20.2	13.5					14.9	13.5	19.1/30.5	13.5/31.2				
32.0	14.4	13.5	18.4	13.5					14.0	13.5	17.9	13.5				
34.0	13.2	13.2	16.8	13.5					13.3	13.3	16.4	13.5				
36.0	11.8	11.8	15.5	13.5					12.1	12.1	15.1	13.5				
38.0	10.6	10.6	14.5	13.5					11.0	11.0	14.0	13.5				
40.0	9.4	9.4	13.7	13.5					9.9	9.9	13.2	13.2				
42.0	8.5/41.1	8.4	13.0	13.0	11.7/43.7				8.9	8.9	12.5	12.5				
44.0		8.2/42.1	12.5	12.4	11.6	11.5/44.5			7.8	7.8	11.9	11.9	10.9/45.5			
46.0			11.9	11.9	11.0	11.0			7.6/44.1	7.3/45.1	11.5	11.5	10.8	10.8/46.2		
48.0			10.7	10.7	10.4	10.4					11.0	11.0	10.2	10.2		
50.0			9.5	9.5	9.8	9.8					10.0	10.0	9.7	9.7		
52.0			9.4/50.1	9.1/51.1	9.3	9.3					9.0	9.0	9.2	9.2		
54.0					8.8	8.8					8.5/53.0	8.2	8.7	8.7		
56.0					8.4	8.4	6.4/56.9	6.3/57.7					8.2	8.2		
58.0					7.9	7.9	6.2	6.2					7.8	7.8	5.8/59.1	5.8/59.9
60.0					7.8/58.7	7.6/59.7	5.9	5.9					7.4	7.4	5.7	5.7
62.0							5.6	5.6					7.1/61.6	7.1	5.4	5.4
64.0							5.3	5.3						7.0/62.7	5.1	5.1
66.0							5.0	5.0							4.9	4.9
68.0							4.9/66.7	4.8/67.7							4.6	4.6
70.0															4.4/69.7	4.4
72.0																4.3/70.7
No. of part line	2	1	2	1	2	1	2	1	2	1	2	1	2	1	2	1

■ w/51.80m Tower

(ton)

Jib length(m) Tower angle(°) Working radius(m)	45.70							
	90		80		70		60	
15.5	17.4							
16.0	17.3	13.5						
18.0	17.2	13.5						
20.0	17.1	13.5						
22.0	16.9	13.5						
24.0	16.5	13.5						
26.0	16.1	13.5						
28.0	15.5	13.5						
30.0	14.5	13.5	16.8/31.8					
32.0	13.6	13.4	16.7	13.5/32.5				
34.0	12.9	12.9	16.0	13.5				
36.0	12.2	12.2	14.7	13.5				
38.0	11.2	11.2	13.6	13.5				
40.0	10.1	10.1	12.8	12.8				
42.0	9.2	9.2	12.0	12.0				
44.0	8.3	8.3	11.4	11.4				
46.0	7.5	7.5	10.9	10.9	10.1/47.2			
48.0	6.9/47.0	6.7	10.5	10.5	10.0	10.0		
50.0			10.2	10.2	9.5	9.5		
52.0			9.3	9.3	9.0	9.0		
54.0			8.5	8.5	8.5	8.5		
56.0			7.6	7.6	8.1	8.1		
58.0				7.3/57.0	7.7	7.7		
60.0					7.3	7.3	5.4/61.2	
62.0					6.9	6.9	5.3	5.3/62.1
64.0					6.6	6.6	5.0	5.0
66.0					6.5/64.6	6.4/65.6	4.7	4.7
68.0							4.5	4.5
70.0							4.2	4.2
72.0							4.0	4.0
74.0							3.9/72.6	3.8/73.6
No. of part line	2	1	2	1	2	1	2	1

■ w/54.85m Tower

(ton)

Jib length(m) Tower angle(°) Working radius(m)	27.45								30.50							
	90		80		70		60		90		80		70		60	
10.8	27.0	13.5/11.3							26.5/11.6							
12.0	27.0	13.5							26.5	13.5/12.1						
14.0	27.0	13.5							26.0	13.5						
16.0	26.0	13.5							25.0	13.5						
18.0	25.0	13.5							24.8	13.5						
20.0	24.3	13.5							24.0	13.5						
22.0	22.2	13.5							21.8	13.5						
24.0	20.4	13.5	24.5/24.6	13.5/25.3					20.0	13.5	23.1/25.9					
26.0	18.4	13.5	24.0	13.5					18.5	13.5	23.0	13.5/26.5				
28.0	15.7	13.5	22.7	13.5					16.8	13.5	21.9	13.5				
30.0	13.1/29.3	13.1	21.1	13.5					14.6	13.5	21.0	13.5				
32.0		12.4/30.3	19.8	13.5					12.5	12.5	19.7	13.5				
34.0			18.7	13.5					11.5/32.3	10.9/33.3	18.3	13.5				
36.0			17.6	13.5	14.0/37.8						17.1	13.5				
38.0			16.2	13.5	13.9	13.5/38.5					16.2	13.5	12.8/39.5			
40.0			15.1/38.8	13.5/39.8	13.1	13.1					15.1	13.5	12.6	12.6/40.3		
42.0					12.4	12.4					13.1/41.8	13.0	12.1	12.1		
44.0					11.6	11.6						12.5/42.8	11.4	11.4		
46.0					10.9	10.9							10.8	10.8		
48.0					10.3	10.3	7.7/49.8						10.1	10.1		
50.0						10.1/49.0	7.6	7.6/50.6					9.6	9.6		
52.0							7.2	7.2					9.3/50.9	9.1/51.9	7.0	
54.0							6.8	6.8							6.6	
56.0							6.4	6.4							6.2	
58.0							6.3/56.5	6.2/57.5							5.9	
60.0															5.6/59.4	
62.0															5.5/60.4	
No. of part line	2	1	2	1	2	1	2	1	2	1	2	1	2	1	2	

■ w/57.90m Tower

(ton)

Jib length(m) Tower angle(°) Working radius(m)	45.70								48.75							
	90		80		70		60		90		80		70		60	
15.5	17.4															
16.0	17.3	13.5														
18.0	17.2	13.5							15.5/16.3	13.5/16.8						
20.0	17.1	13.5							15.0	13.5						
22.0	16.2	13.5							14.5	13.3						
24.0	15.5	13.5							14.1	12.9						
26.0	14.9	13.5							13.7	12.5						
28.0	14.4	13.4							13.4	12.1						
30.0	14.0	13.0							13.1	11.8						
32.0	13.5	12.8							12.7	11.5						
34.0	12.8	12.6	13.3/32.9	12.3/33.5					12.5	11.2						
36.0	12.2	12.2	13.0	12.2					12.2	10.9	12.1/34.2	11.3/34.8				
38.0	11.1	11.1	12.5	11.7					11.7	10.7	11.7	11.0				
40.0	10.1	10.1	12.0	11.3					11.2	10.5	11.2	10.5				
42.0	9.2	9.2	11.7	10.9					10.2	10.1	10.8	10.2				
44.0	8.3	8.3	11.4	10.6					9.3	9.3	10.5	9.9				
46.0	7.4	7.4	11.2	10.4					8.5	8.5	10.2	9.6				
48.0	7.0/47.0	6.7	11.0	10.3					7.7	7.7	10.1	9.5				
50.0			10.7	10.2	8.7/49.3				7.0	7.0	9.9	9.3				
52.0			10.3	10.1	8.5	8.5			6.2/49.9	6.2	9.8	9.2	8.0/51.0	7.7/51.8		
54.0			9.8	9.8	8.1	8.1				6.0/51.0	9.5	9.1	7.8	7.7		
56.0			8.9	8.9	7.7	7.7					9.0	9.0	7.4	7.4		
58.0			8.0	8.0	7.4	7.4					8.3	8.3	7.1	7.1		
60.0			7.6/57.0	7.3	7.1	7.1					7.5	7.5	6.7	6.7		
62.0					6.7	6.7					6.8	6.8	6.4	6.4		
64.0					6.4	6.4						6.6/61.0	6.2	6.2		
66.0					6.0	6.0	4.1/64.3	4.0/65.1					5.9	5.9		
68.0					5.7	5.7	3.9	3.9					5.6	5.6	3.6/66.4	3.6/67.3
70.0					5.6/66.7	5.5/67.7	3.7	3.7					5.3	5.3	3.5	3.5
72.0							3.5	3.5					5.1/69.6	5.1	3.3	3.3
74.0							3.3	3.3						5.0/70.6	3.1	3.1
76.0							3.1	3.1							2.9	2.9
78.0							2.9/75.7	2.9							2.7	2.7
80.0							2.8/76.7								2.5	2.5
															2.5/78.6	2.4/79.6
No. of part line	2	1	2	1	2	1	2	1	2	1	2	1	2	1	2	1

- Notes: 1. Capacities are the maximum allowable and based on machine standing level on firm supporting surface under ideal job conditions.
 2. Capacities are determined in accordance with EN13000 standards in terms of machine stability and structural strength limitations.
 3. Capacities surrounded by bold lines are based on factors other than those which would cause a tipping condition.
 4. Capacities are based on freely suspended loads and make no allowance for such factors as the effect of wind, sudden stop of loads, supporting surface conditions and operating speed. Operator must reduce load ratings to take such conditions into account.
 5. Deduction from rated capacities must be made for weight of hook block, hook ball, sling, spreader bar or any suspended gear.
 6. 80.6ton counterweight and 27.4ton lower frame counterweight are required for all capacities on this chart.

■ Combination Table

Jib length (m) Tower length (m)	27.45	30.50	33.50	36.55	39.60	42.65	45.70	48.75
36.55	⊙	⊙	×	×	×	×	×	×
39.60	⊙	⊙	⊙	×	×	×	×	×
42.65	⊙	⊙	⊙	⊙	×	×	×	×
45.70	⊙	⊙	⊙	⊙	⊙	×	×	×
48.75	⊙	⊙	⊙	⊙	⊙	⊙	×	×
51.80	⊙	⊙	⊙	⊙	⊙	⊙	⊙	×
54.85	⊙	⊙	⊙	⊙	⊙	⊙	⊙	⊙
57.90	⊙	⊙	⊙	⊙	⊙	⊙	⊙	⊙

Notes:

- The meaning of symbols shown in the above table is as follows;
 1. Symbol of "⊙": Possible to luff tower between 90° thru 60°;
 2. Symbol of "×": Impossible to make any of tower boom and jib combination.

Luffing jib Working Range

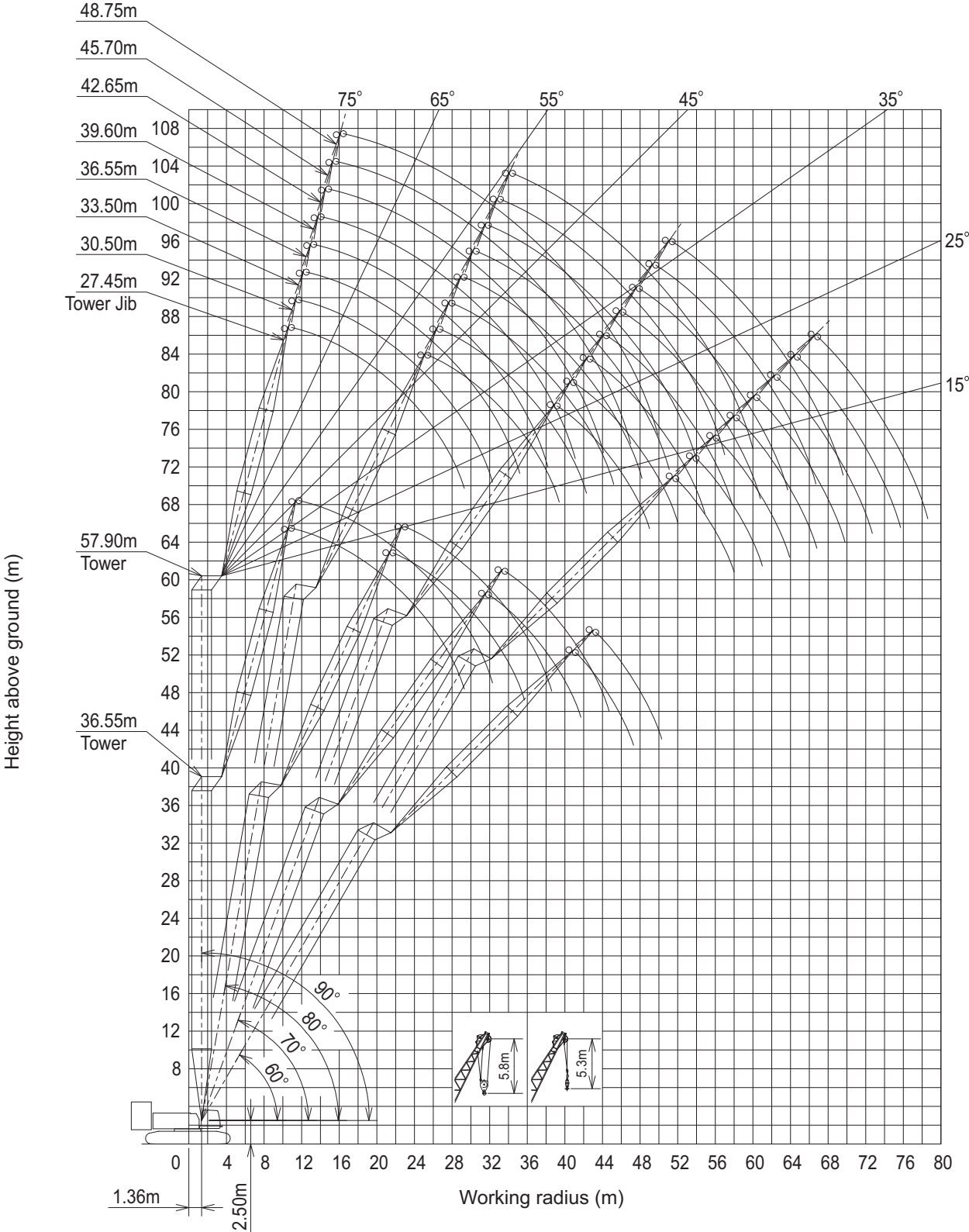

Tower Boom & Jib Combination Table

■ Tower boom configurations

Tower Length (m)	Tower Configuration	Tower Length (m)	Tower Configuration
36.55	★ 7.6 6B 3 6 9B 3	48.75	★ 7.6 6B 9 9B 3 3 9
	7.6 6B 9 9B 3		7.6 6B 9 9B 6 9
39.60	★ 7.6 6B 9 9B 3 3	51.80	★ 7.6 6B 9 9B 3 6 9
	7.6 6B 9 9B 6		7.6 6B 9 9B 9 9
42.65	★ 7.6 6B 9 9B 3 6	54.85	★ 7.6 6B 9 9B 3 3 6 9
	7.6 6B 9 9B 9		7.6 6B 9 9B 3 9 9
45.70	★ 7.6 6B 9 9B 3 3 6	57.90	★ 7.6 6B 9 9B 3 3 9 9
	7.6 6B 9 9B 3 9		7.6 6B 9 9B 6 9 9











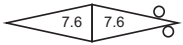
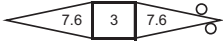
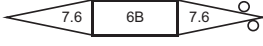
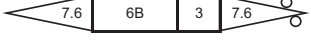
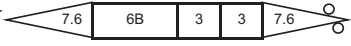

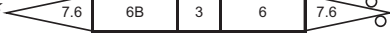
Note: A star mark (★) indicates manufacturer's recommended boom configurations those are able to set the boom length in 3.05 meters pitch. If other boom configuration is required other than above, please consult us or nearest distributor.

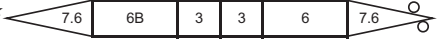
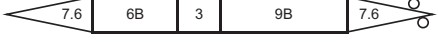
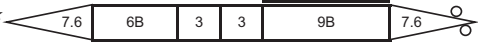
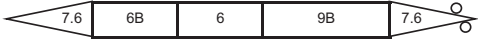
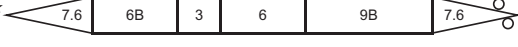
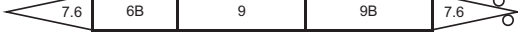
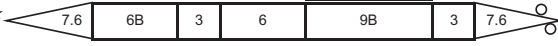









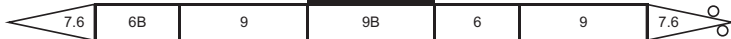

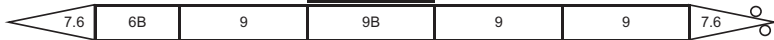



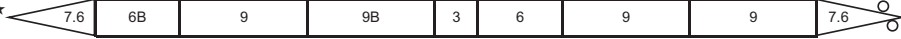

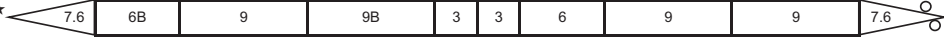
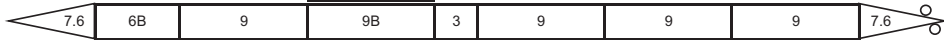
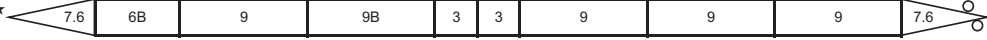
■ Tower jib configurations

Tower Jib Length (m)	Tower Jib Configuration	Tower Jib Length (m)	Tower Jib Configuration
27.45	<p>1 Balance Weight</p>	39.60	
30.50	<p>1 Balance Weight</p>	42.65	
33.50		45.70	
36.55		48.75	

Note: A star mark (★) indicates manufacturer's recommended boom configurations those are able to set the boom length in 3.05 met
If other boom configuration is required other than above, please consult us or nearest distributor.

■ Crane boom configuration with tower boom extensions

Boom Length (m)	Boom Configuration
15.25	
18.30	
21.35	
24.40	
27.45	★ 
	
30.50	★ 
	
33.55	★ 
	
36.60	★ 
	
39.65	★ 
	
42.70	★ 
	
45.75	★ 
	
48.80	★ 
	
51.85	★ 
	

Boom Length (m)	Boom Configuration
54.90	<p>★ </p> <p></p>
57.95	<p>★ </p> <p></p>
61.00	<p>★ </p> <p></p>
64.05	<p>★ </p> <p></p>
67.10	<p>★ </p> <p></p>
70.15	<p>★ </p> <p></p>
73.20	<p>★ </p> <p></p>
76.25	<p>★ </p> <p></p>
79.30	<p>★ </p> <p></p>
82.35	<p>★ </p> <p></p>
85.40	<p>★ </p> <p></p>

Note: A star mark (★) indicates manufacturer's recommended boom configurations those are able to set the boom length in 3.05 meters pitch. If other boom configuration is required other than above, please consult us or nearest distributor.

Transport Data

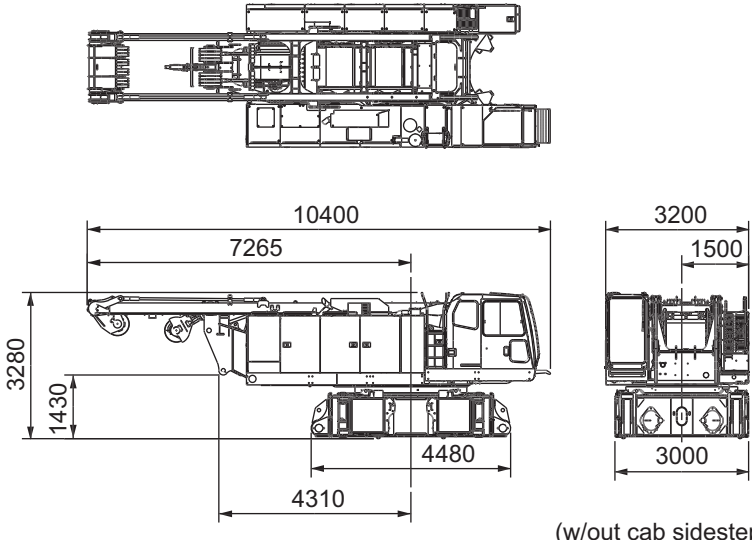
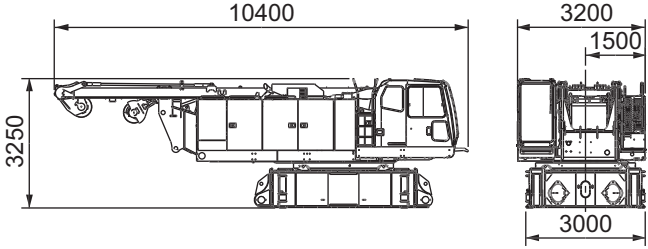
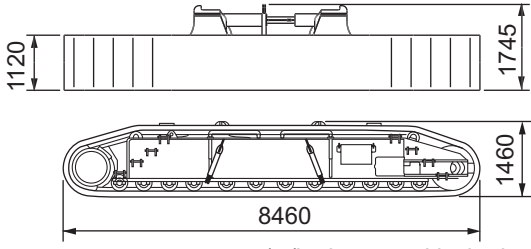
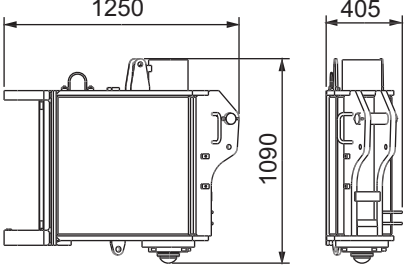
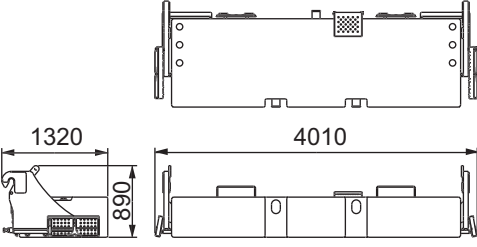
Description	Q'ty	Dimensions(mm)	Mass(kg)
<p>Superstructure with:</p> <ol style="list-style-type: none"> 1. Lower frame; 2. Boom live mast w/bridle; 3. Front drum cable; 4. B/H drum cable, 5. Lower frame jack-up device. 	1	 <p>(w/out cab sidestep)</p>	40,000
<p>Superstructure with:</p> <ol style="list-style-type: none"> 1. Lower frame; 2. Boom live mast w/bridle; 3. Front drum cable, 4. B/H drum cable. 	1	 <p>(w/out lower frame jack-up device & cab sidestep)</p>	37,800
Crawler Side Frame	2	 <p>(w/hyd. removal jack-pins & cylinder)</p>	@18,700
Lower frame Jack-up Cylinder (w/beam)	4		@550
Lower Weight	2		@13,800

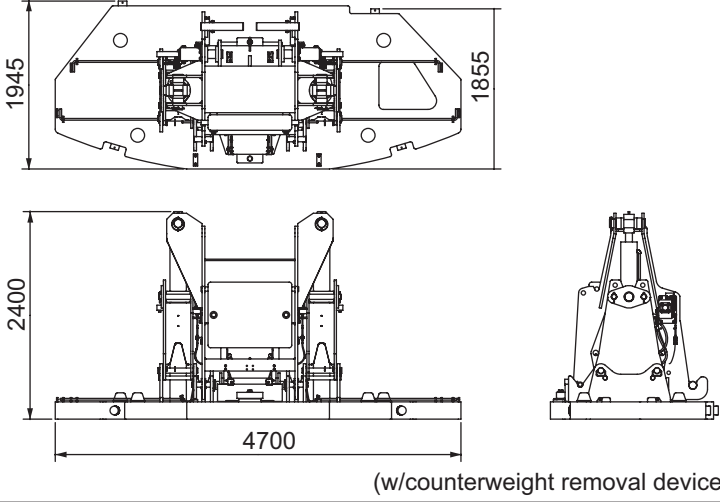
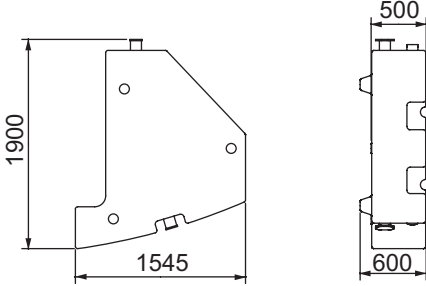
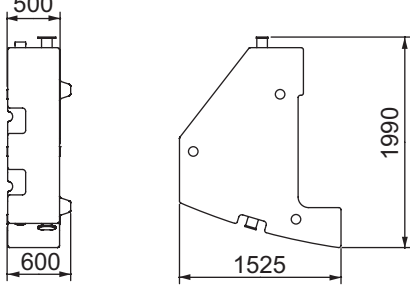
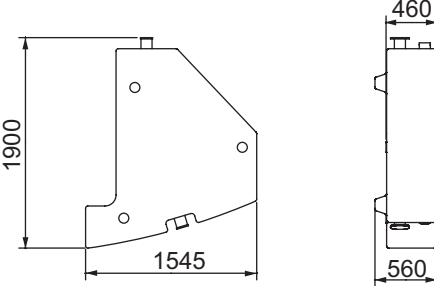
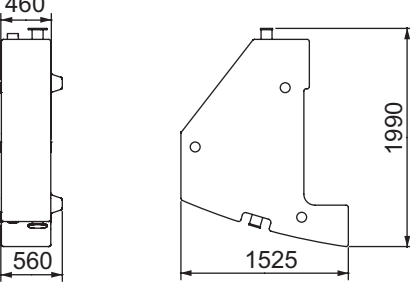
Description	Q'ty	Dimensions(mm)	Mass(kg)
Base Counterweight	1	 <p>(w/counterweight removal device)</p>	17,800
Counterweight "R1"	3		@5,500
Counterweight "L1"	3		@5,800
Counterweight "R2"	3		@4,600
Counterweight "L2"	3		@5,000

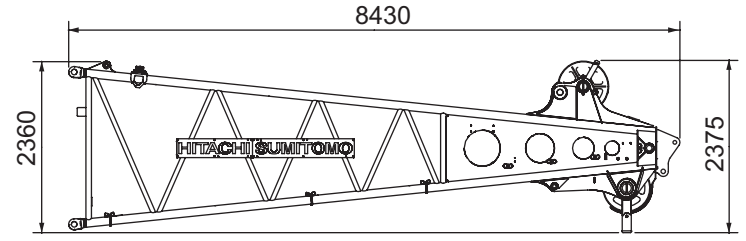
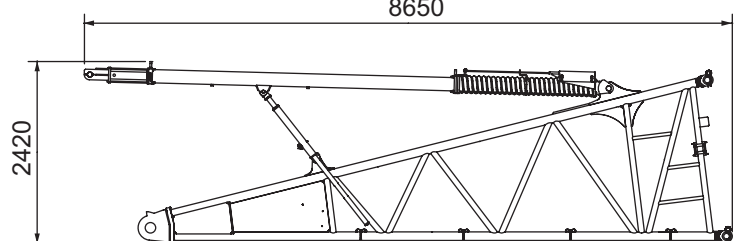
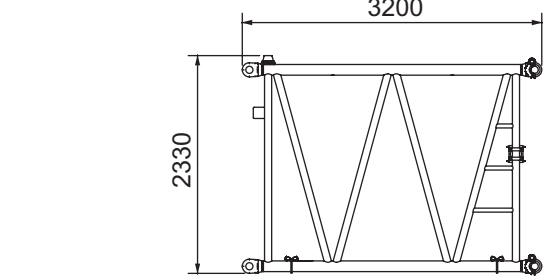
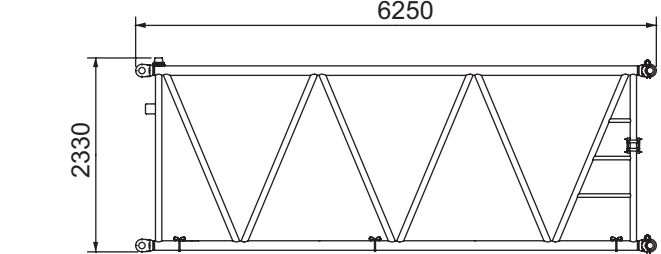
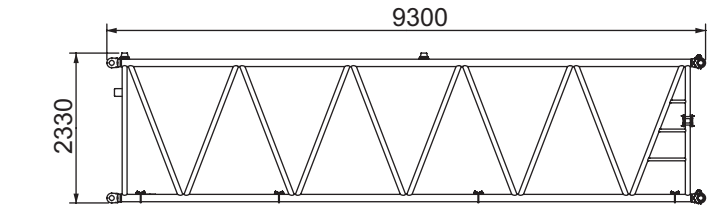
Description	Q'ty	Dimensions(mm)	Mass(kg)
7.62m Boom Top Section	1	 <p>width:2240 (w/pendant ropes)</p>	3,200
7.62m Boom Base Section (w/backstops)	1	 <p>width:2260</p>	3,800
3.05m Boom Extension	1	 <p>width:2260 (w/out pendant ropes)</p>	700
6.10m Boom Extension	1	 <p>width:2260 (w/out pendant ropes)</p>	1,100
9.15m Boom Extension	1	 <p>width:2260 (w/out pendant ropes)</p>	1,600

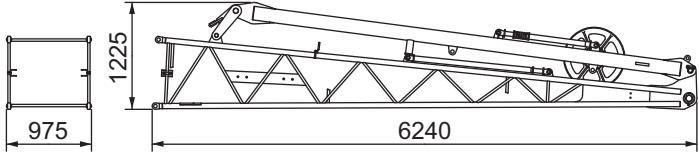
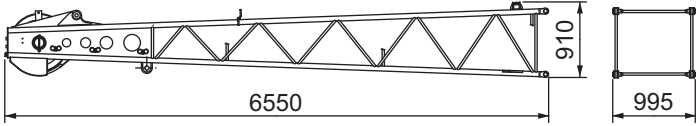
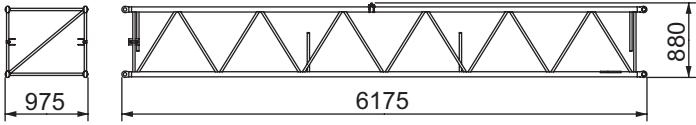
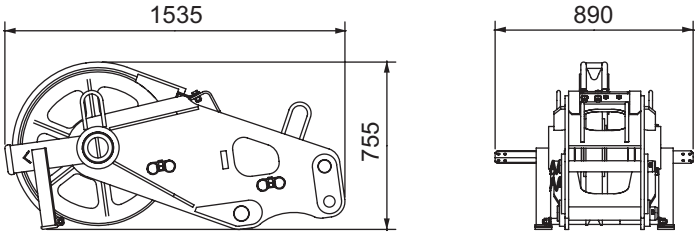
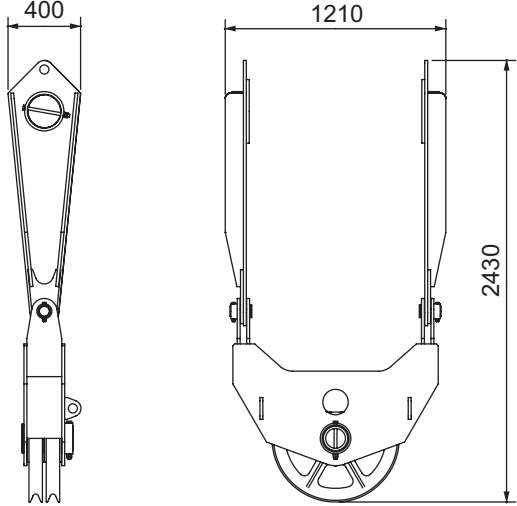
Description	Q'ty	Dimensions(mm)	Mass(kg)
6.10m Fly Jib Base Section (w/strut)	1	 <p data-bbox="1070 607 1310 640">(w/out pendant ropes)</p>	1,000
6.10m Fly Jib Top Section	1	 <p data-bbox="1070 887 1310 920">(w/out pendant ropes)</p>	500
6.10m Fly Jib Extension	1	 <p data-bbox="1070 1178 1310 1211">(w/out pendant ropes)</p>	250
Short Jib	1		300
Upper 2-hanger Sheave Block	1	 <p data-bbox="555 2051 1318 2107">Note: This is pinned to boom head shaft, and available to lift the load exceeding 160t, and up to 200t.</p>	480

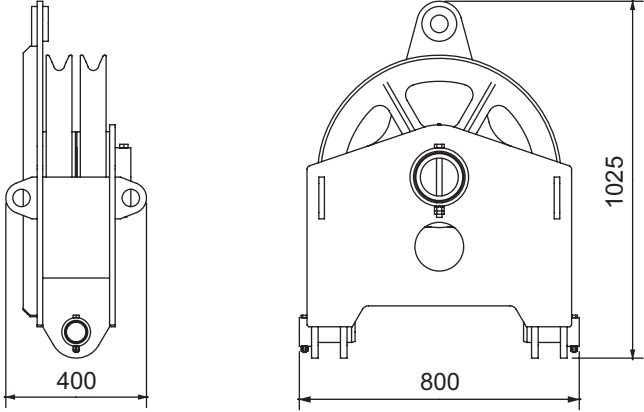
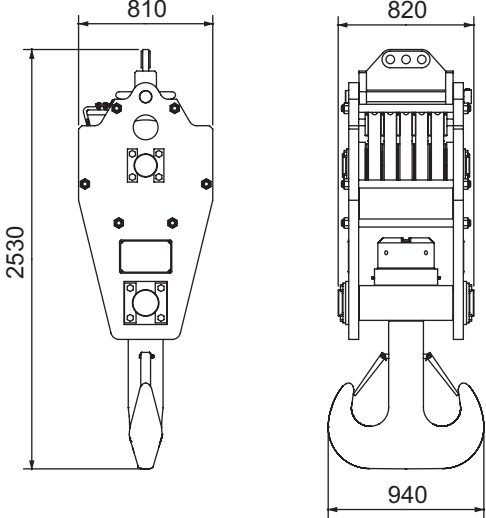
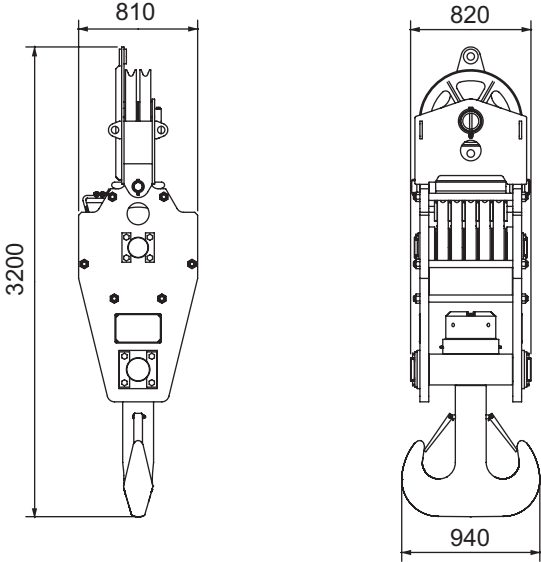
Description	Q'ty	Dimensions(mm)	Mass(kg)
Lower 2 -hanger Sheave Block	1	 <p data-bbox="539 891 1318 943">Note: This is pinned to 135t hook block, and available to lift the load exceeding 160t, and up to 200t.</p>	270
135t Hook Block	1		2,600
200t Hook Block (135t hook block w/2-hanger sheave block)	1		2,870

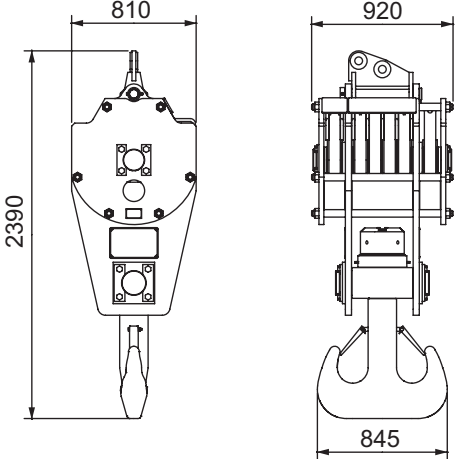
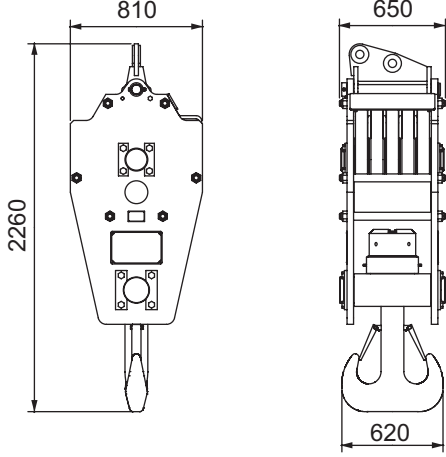
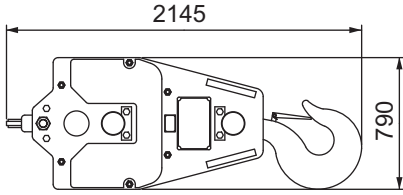
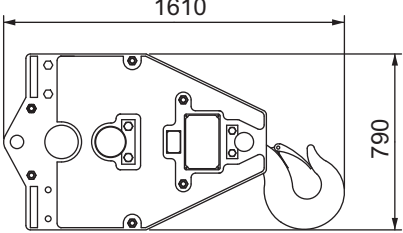
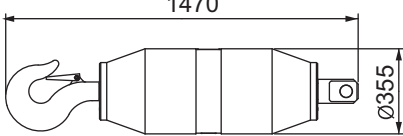
Description	Q'ty	Dimensions(mm)	Mass(kg)
160t Hook Block	1		2,180
120t Hook Block	1		1,640
80t Hook Block	1		1,390
35t/27t Hook Block	1		940
13.5t Ball Hook Block	1		620

Note: All of dimensional figures are of with no export packing; in the case that an export packing is done on each cargo,the dimension in height or height/width or height/width/length increases appropriately, and then cubic measurement and mass each comes up accordingly.

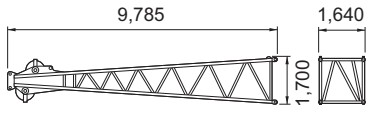
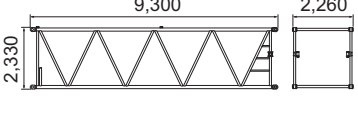
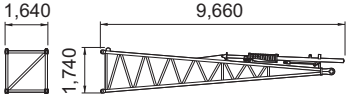
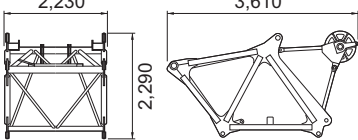
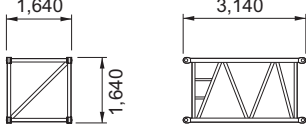
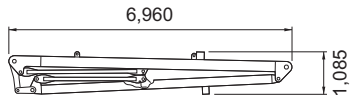
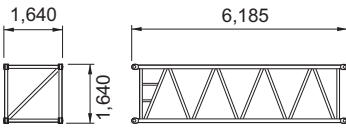
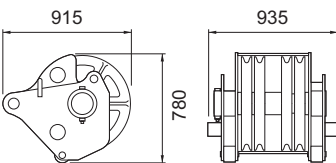
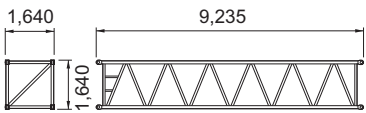
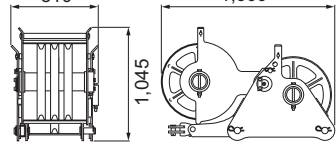
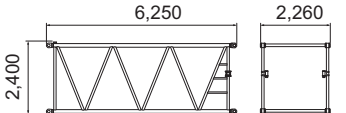
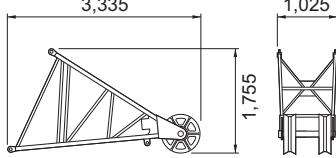
Description	Q'ty	Dimensions(mm)	Mass (kg)	Description	Q'ty	Dimensions(mm)	Mass (kg)
Tower jib Top section	1	 (w/ pendant ropes)	1,500	9.15m special Tower boom Extension	1	 (w/o pendant ropes)	1,670
Tower jib Base Section (w/Backstops)	1		1,900	Tower Head Section	1 1		1,500
3.05m Tower jib Extension	1	 (w/o pendant ropes)	400	Front & Rear Post	1	 width: 2,270	1,600
6.10m Tower jib Extension	1	 (w/o pendant ropes)	700	Tower jib Bridle	1		500
9.15m Tower jib Extension	1	 (w/o pendant ropes)	900	Tower jib Hanger	1		750
6.10m special Tower boom Extension	1	 (w/o pendant ropes)	1,690	Roller Braket	1		400

Standard and Optional Equipment

	Standard equipment	Optional equipment
Superstructure	<ul style="list-style-type: none"> • Mitsubishi 6M70-TL diesel engine with a 272kW <370ps> rated output; • Hydraulic system with three variable displacement axial piston pumps and one fixed displacement duplicate tandem gear pump; provided with an aluminum-make independent oil cooler; • Control system with one each of quadruplicate and triplicate tandem valves and pilot-operated arm chair single axis control levers; provided with motorcycle type "EPC" controller (easy-precise-minute engine rpm and hyd. pump oil flow control device), and specially-tailored pressure compensating valves. In addition, drum rotation speed controller is designed on; • Front and rear main operating drum winches of 245kN<25t> line pull with 596mm dia. drum lagging driven by independent variable hyd. motor; each provided with multiple wet-disc type automatic brake with no free-fall function; • Boom hoist mechanism with a twin-drum design driven by a hyd. motor with automatic brakes; provided with drum rotation speed control design; • Slewing mechanism with heavy-duty turntable bearing; driven by two hyd. motors w/spring-applied, power hydraulically released multiple wet-disc brakes; provided with speed control design; • Bail frame with a 10-sheave machinery and single center sheave; pinned to a rear part of upper revolving frame; • 940mm wide, full-vision operator's cab with a stamped-and-rounded corner design and large front window; provided with an arrangement of armchair operator control station and instrument panel. Air-conditioner is provided too; • An 80.6ton counterweight; provided with a self-removal device for full weight; • Machinery cab with hinged doors; • 24-volt electrical system with two 12-volt batteries; • Lighting system: <ul style="list-style-type: none"> • Two 70W working lights; • One 10W interior cab light; • Rear view mirrors; • Accessories: <ul style="list-style-type: none"> • AM/FM radio w/clock; • Engine hourmeter; • Engine tachometer; indicated on display panel of LMI; • Fuel gauge; • Eng. water temp. gauge; • Engine over-heat indicator; available on display panel of LMI; • Hyd. oil over-temp. indicator; available on display panel of LMI; • 24V electric outlet; • Dual, intermittent window shield wipers with washers; available on both front and roof windows; • Cigar lighter; • Ashtray; • Book holder; • Sunvisor; • Sunshade; • Cup Holder; • Non-skid surfaces; • Cab floor mat; • Cab front step; • Cab side step; • Superstructure under-cover; • Std. spare parts and tools; • Centralized lubrication system (for livemast and slewing circle); • Gripping bar (for cab side step). 	<ul style="list-style-type: none"> • Drum rollers; available on front/rear main drums; • Catwalks; • "Quick-Draw" hydraulic cylinder with hook; • Re-fuel pump; • Microphone & loud-speaker. • Engine foot throttle; • Fire extinguisher; • Hyd. tagline*; (wire rope ϕ10mmx55m) • Reeving winch*; (wire rope ϕ8mmx250m) • Hydraulic tagline with reeving winch; • Front and rear main operating winch drums available to operate in two brake modes of automatic and free-fall functions, i/o std.; provided with clutchless, multiple wet-disc brake unit on each drums; <p>Please consult us or distributor in case each single items with marked "*" are required to install simultaneously.</p>

	Standard equipment	Optional equipment
Undercarriage	<ul style="list-style-type: none"> • 5,860mm gauge by 8,460mm long crawler lower with removable crawler side frames; provided with four of heavy duty tip blocks with pins, lugs; • Crawler drive units with shoe-in type traction motor with wet-disc type automatic brakes provided with hyd. removal joint-pin with cylinder; • 1,120mm wide track shoes; • Manual track tension adjusting devices; • Lower frame jack-up device w/4-vertical hyd. jack-up cylinder and remote control unit; • 27.6ton lower weight; • Lifetime lubricated track components; • Crawler side steps. 	<ul style="list-style-type: none"> • Automatic track tension adjusting device, i/o manual one as std.
Liftcrane Att.	<ul style="list-style-type: none"> • 15.25m basic crane boom; 7.62m base section, and 7.62m tapered top section w/six head sheaves, and two guide sheaves; provided with boom foot pin removal cylinders; • Boom live mast and bridle frame with a 10-sheave machinery; • Main crane hoist cable; 28mm dia./410m long; • Boom hoist cable; 22.4mm dia./275m long; 	<ul style="list-style-type: none"> • 3.05m boom extension; • 6.10m boom extension; • 9.15m boom extension; • 12.20m basic fly jib; 6.10m base and top sections with jib strut and boom/jib guyline pendants; • 6.10m fly jib extension; • Short jib; • 200/135t with a lower 2-hanger sheave block; • 160t hook block; • 120t hook block; • 80t hook block; • 35t/27t hook block; • 13.5t ball hook; • Upper 2-hanger sheave block (pinned to boom head shaft); required together with 200t hook block when lifting load exceeds 160ton, and available up to 200ton lift; • Aux. crane hoist cable, 28mm dia./300m long; available for fly jib application; • Aux. crane hoist cable, 28mm/185m long; available for short jib application; • Boom skywalk; available for all sections of lift crane main boom.
Towercrane Att.		See towercrane Att. mentioned into page21.

	Standard equipment	Optional equipment
Safety Devices	<ul style="list-style-type: none"> ● Load Moment Indicator; this is a computerized automatic over-load preventing system incl. total safe operation control system; provided with a graphic display panel indicating ten and some kinds of present lifting conditions; ● Lock lever (Fool proof shut-off lever); ● Emergency engine stop switch; ● Speed slowdown device; ● Before-work check monitor; ● LMI safety circuit-off switch; ● Main hook over-hoisting limiter; ● Boom over-hoisting and lowering limiter; ● Secondary boom over-hoisting limiter; ● Slewing alarm; ● Travel alarm; ● Slew lock; ● Independent lever lock; ● Main and aux. drum pawl locks; ● Boom hoist drum pawl lock (w/automatic locking device); ● Lifting height indication device; ● Boom angle indicator; ● Level gauge; fitted on floor of operator's cab and a part of undercarriage; ● Slewing brake lamp; ● Warning lamps; available for pilot line; ● Slewing brake safety circuit; ● Signal horn; ● Hook latch; ● Engine monitoring lamps; ● Travel direction arrow; ● Front-end att. erection mode; ● Boom backstops. 	<ul style="list-style-type: none"> ● Aux. hook over-hoisting limiter; ● Three color percentage indicator; ● LMI mode select switch; ● Anemometer; ● Drum light & mirror; ● Free fall interlocking; ● Non drum brake preventing device. <p>Followings are standard in case of tower jib attachment;</p> <ul style="list-style-type: none"> ● Tower jib angle detector; ● Tower jib load detector; ● Tower jib hook over-hoisting limiter; ● Tower jib over-hoisting and-lowering limiter; ● Tower jib hoist drum pawl lock; ● Tower jib backstops; ● Secondary tower jib over-hoisting limiter.

MEMO

A series of horizontal dotted lines for writing.

MEMO

A series of horizontal dotted lines for writing.

SCX2000A-2

Hitachi Sumitomo Heavy Industries Construction Crane Co., Ltd.

9-3, Higashi Ueno 6-chome, Taito-ku, Tokyo 110-0015, Japan
Phone: 81-3-3845-1387 Facsimile: 81-3-3845-1394
<http://www.hsc-crane.com>

- We are constantly improving our products and therefore reserve the right to change designs and specifications without notice.
- Units in this specification are shown under International System of Units; the figures in parenthesis are under Gravitational System of Units as old one.

Address Inquires to: