

SCX2000A-2

HITACHI SUMITOMO

ASIAN ISSUE

SCX2000A-2

GENERAL DIMENSIONS

Unit : mm

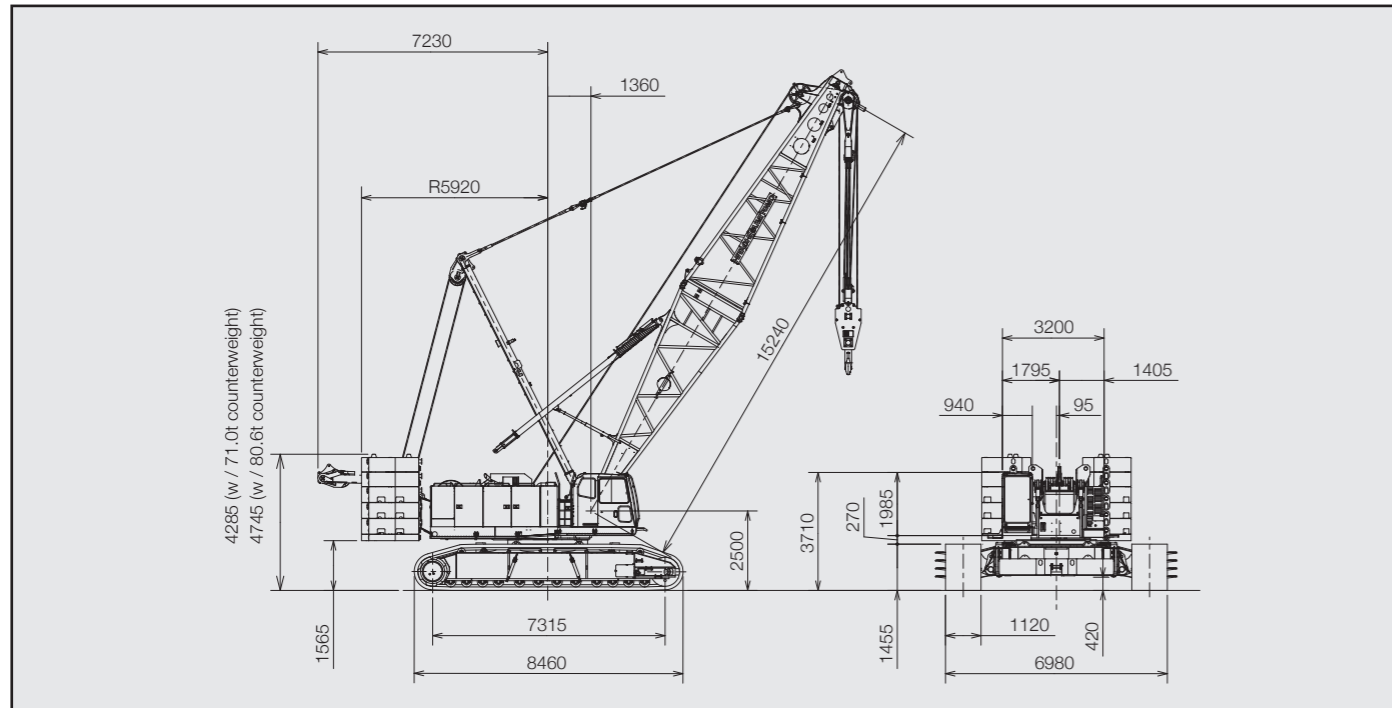

SPECIFICATIONS

		Liftcrane application	Luffing towercrane application	Clamshell application
Max. lifting Capacity	t x m	200 x 4.6	27 x 14.0	-
Basic boom length	m	15.2	-	15.2
Main boom length	m	85.4	-	27.4
Fly jib length	m	12.2 ~ 30.5	-	-
Boom + fly jib length	m	73.2 + 30.5	-	-
Tower length	m	-	36.5 ~ 57.9	-
Tower jib length	m	-	27.4 ~ 48.7	-
Tower + jib length	m	-	57.9 + 48.7	-
Front / Rear main drum rope line speed*	m / min	110 / 110	110 / -	60
Boom hoist rope line speed*	m / min	32 x 2	32 x 2	32 x 2
Tower jib hoist rope line speed*	m / min	-	55	-
Swing speed*	min ⁻¹ (rpm)	-	1.7 (1.7)	-
Travel speed*	km / h	-	1.2 / 0.6	-
Gradability	% (°)	-	30 (17)	-
Power unit (Make & model)		Mitsubishi 6M70-TL		
Rated output	kW/min ⁻¹ (PS/rpm)	272 / 2000 (370 / 2000)	272 / 2000(370 / 2000)	272 / 2000 (370 / 2000)
Ground contact pressure	kPa (kgf/cm ²)	Approx. 111 (1.13) (w / basic boom)	Approx. 128 (1.31)	Approx. 88.7 (0.91)
		Approx. 117 (1.20) (w / 18.3m)	-	-
Operating weight	t	Approx. 186 (w / basic boom)	Approx. 215t (w / max. tower + jib)	Approx. 148t (w / basic boom)
		Approx. 196 (w / 18.3m boom)	-	-

* Varies with the load.

- We are constantly improving our products and therefore reserve the right to change designs and specifications without notice.
- The images used in this catalog may differ from those of the machine acquired with the sales specifications.
- These images are photographed having conducted scene directions.
- When leaving the machine, ensure safety by always setting a work device or by other measures.

- The colors of the images on this catalog may differ from actual colors due to the printing process.
- Before using this machine, be sure to read the operator's manual.
- When operating transportable cranes with lifting loads of 5t or more, the qualification of a "driving license for transportable cranes" is required.
- Also, only individuals with an applicable operational qualification or training certificate may use the machine except for craning purpose.

Address inquires to :

Hitachi Sumitomo Heavy Industries Construction Crane Co., Ltd.

9-3, Higashi Ueno 6-chome, Taito-ku, Tokyo 110-0015, Japan
 Phone: 81-3-3845-1387 Facsimile: 81-3-3845-1394
<http://www.hsc-crane.com>

Printed in Japan
 1403 © 05H.EA154-3a
 (3rd Edition)



SCX2000A-2

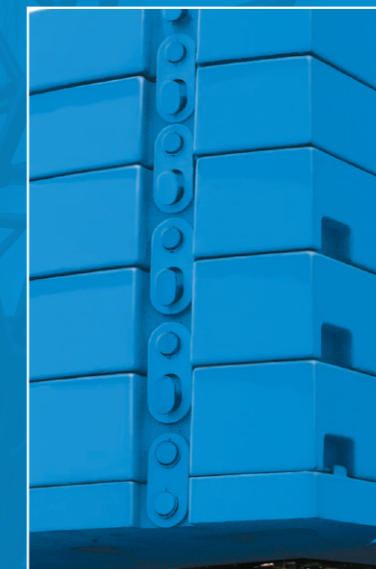

Discover its higher performance

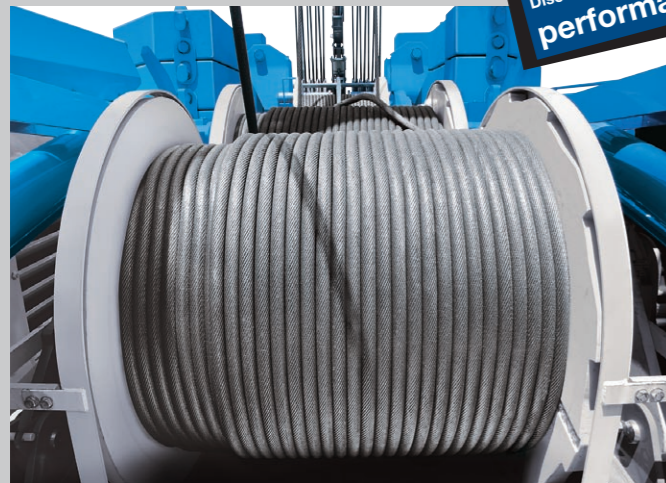

A concept to select a 200t class machine

The power and capacity can alter conventional concept within the class

Although the machine size is almost the same as the 180t class machines, an excellent performance equivalent to that of the 250t class machines is achieved (compared to our conventional machines). In addition, effort has been applied to the details of the machine used for its functional ability of assembling/disassembling and those to secure safety, that were available for the upper class models, have been adopted to design of the machine. Efficiency is substantially improved by ensuring a comfortable and safe operational environment while inheriting the highly-reputed durability and visibility from higher class models realizing a reliable partner machine.



SCX2000A-2

[Maximum rated load]
Crane specification: 200t x 4.6m

“High line pull” available for superior lifting performance **245kN**

By combining the high-output engine and EPC system, a 245kN (25t) high line pull winch for both front and rear drums is realized, which surely provides superior lifting performance.

Ascertained workability realized by the “rope line speed” **110m/min**

The maximum rope line speed is 110m/min efficiently facilitating even high lift working; moreover, a freefall-less winch is equipped as standard along with sufficient safety considerations.

Achieving high work efficiency by “wide drum” **58m**

Front and rear drums have 28mm wire rope and its capacity at the first layer is 58m with 30 wraps. These wire drums reduce the deshelled layering and wear of the wire rope to the absolute minimum, not only extending the wire life but also enhancing operational efficiency during crane and luffing operations.

“A high output engine” equivalent to 275t class machines **272kW**

A high output engine generating 272kW (370PS) equivalent to the 275t class engine is equipped. Its ample output setting supports the machine’s superior lifting performance.

A high lifting ability exceeding that of 150t class machines and with power equivalent to 275t class machines

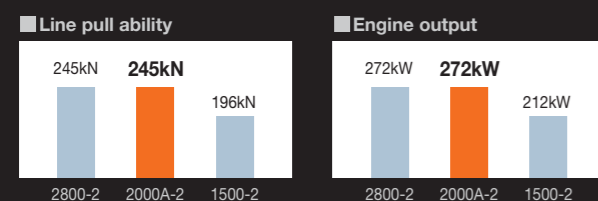

The maximum lifting ability is 200t x 4.6m, improved by 33% compared with our conventional 150t class machines. The engine rated output is 272kW, realizing a level of performance equivalent to that of the engine adopted to our 275t class machines. Stable operations are therefore achieved.

Qualifying to present-day environmental standards

Conforming to European exhaust gas emission regulations

By equipping with a low pollution engine, emissions of nitrogen oxide (NOx) and particulate matter (PM), etc. are reduced to an absolute minimum. This ensures compliance with the “Tier III emission regulations” effective in North America, Europe, and Japan.

The use of hazardous substances is controlled with due consideration

Based on Hitachi Construction Machinery’s strict and unique environment management program, the SCX2000A-2 has been created not only by adopting lead-free aluminum radiators, oil coolers and intercoolers, etc. but also by pursuing efforts to achieve guaranteed safety of materials, structure, segregation and disposal.

Achieving a 99% recycling rate (by weight)

The counterweights comprising 30% of the total machine weight are made of castings. In addition, a 99% recycling rate is achieved relative to the material weight.

* The image includes optional specifications.

Discover its higher
**assembling
 capability** and
transportability

**Increase the efficiency of assembling/
 disassembling for more compact work
 spaces and at lower cost**

The assembling/disassembling ability has a decisive influence on the construction schedule. The SCX2000A-2 adopts a self-assembling device which is also used on our 275t class machines. By facilitating a “quick draw system” enabling the machine’s own boom live-mast to be used as a supporting crane for self-assembly, the crane can be assembled easily and simply on an SCX2000A-2 machine.

* The quick draw mechanism is optional.

**Improving the efficiency of
 assembling/disassembling
 to a higher grade
 “Counterweight
 self installing/
 removal device”**

The counterweight can be assembled by yourself and installed to the machine body by combining a quick draw system and a counterweight self installing/removal device. Together with the simplicity of the assembling and installation procedures, this contributes significantly to the cost and workforce reductions required for assembling/disassembling.



**“Quick draw”,
 the mechanism to enable
 self-assembly**

Option

* The photograph image represents a sample.



The “quick draw system” is adopted on our upper class machines and has been highly evaluated. In this mechanism, a cylinder is installed to a mast and is used for its assembly regarding it as a supporting crane. Consequently, quick and efficient assembling/disassembling is realized helping reduce the work space required.

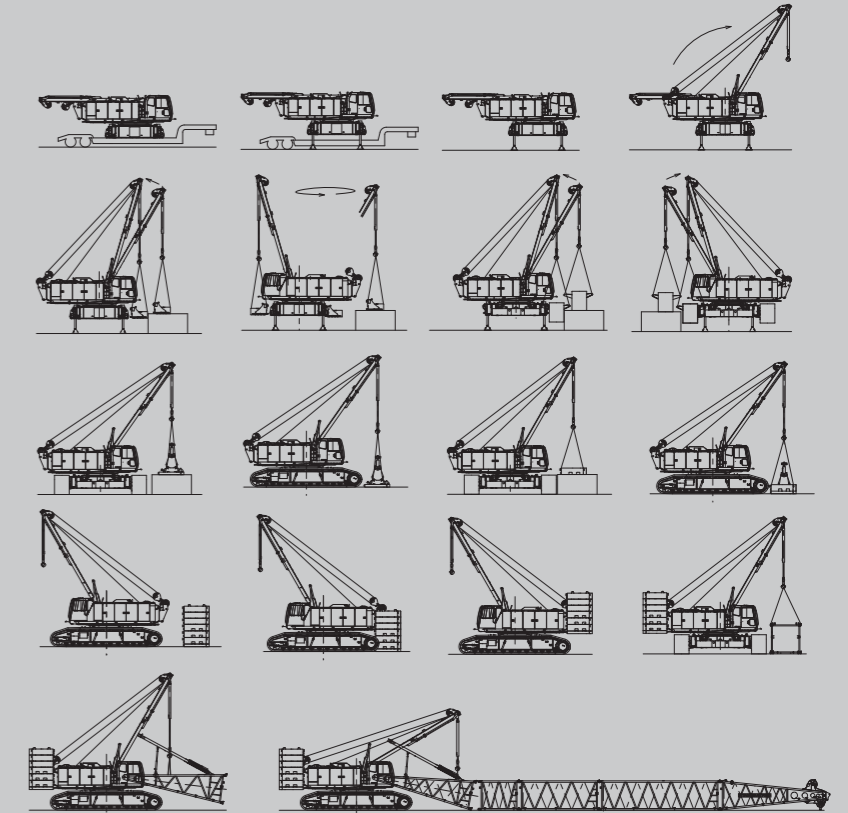

**Swift installing/removal of the side
 frame achieved by a “hook-on
 design”**

A cylinder joint method is adopted to install the side frame to the machine body. Assembling/disassembling is swiftly performed thanks to the use of a simple structure with a hook on an attached pin and a hydraulic cylinder for fixing.

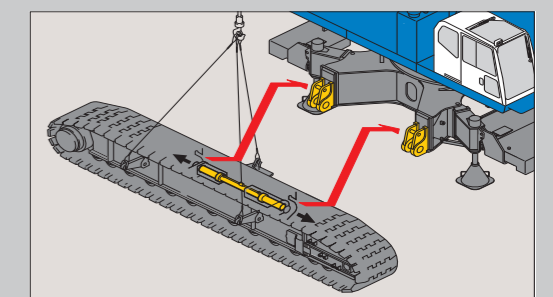

* The image includes optional specifications.

Discover its higher
maneuverability and
comfortability

Maneuverability responding precisely and accurately, and comfortability achieved by reducing the operation loads

Only accurate transmission of the operation can achieve the excellent performance. The SCX2000A-2 operator's cab is equipped with various functionalities, establishing an overall system satisfying operator sensibility; moreover, the machine also ensures adequate comfort reducing the operator burden and supporting exact operations.

The operation view is wider as ever

By adopting armchair control levers, the front visibility has been substantially improved, enlarged to 51.5 degrees. This adoption has also expanded the visibility of the upward view like below illustration.

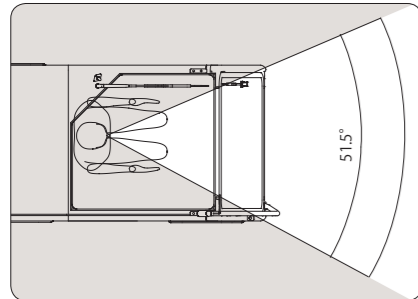

Front view angle

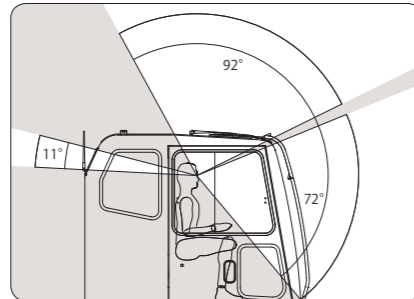

Upward view angle

Advanced functionalities for maneuverability and comfortability

Enabling simultaneous control of the engine and pump
"EPC system"



The slewing control lever is also equipped with a grip throttle. By turning this, the speed is controlled sequentially from low to maximum speed. In addition, the engine and pump can be controlled by one hand.

Transmitting the drum rotation through vibration
"Armchair control levers"

A control lever is allocated to the side of the operator's seat realizing control with easy posture; moreover, a "drum rotation sensor," a device allowing drum rotations to be transmitted to the operator's hand through vibrations, is equipped as standard. This enables operations requiring accurate control such as bolt hole matching even when the lifting load is not visible.

Easy-to-see and functionally-designed layout screen
"Control panel"

An easy-to-see large LCD display panel is adopted and meters and switches allocated according to their functions. Consequently, this helps to ensure a simple and easily viewable information control panel.

Arbitrarily setting different speeds for hoisting and boom hoisting
"Drum rotation speed control dial"

The drum rotation speed is adjustable with a dial. In addition, according to the purpose of the operation, different speeds may be set arbitrarily for hoisting and boom hoisting.

Effective for high lift working
"Slewing speed control dial"



The slewing speed is controlled by a dial and effective for high lift crane working, etc. when the crane has to be operated with a high hoisting speed but low slewing speed.

The safety measures reducing various risks

Discover its higher
safety

Automatic control

Protection from overload thanks to excellent visibility

"LMI (Load Moment Indicator)"



The load applied to the machine is immediately calculated and displayed. With an easy-to-see LCD graphic display panel, the current status of the load can always be seen; moreover, a very visible letter message is displayed during any overload and these functions help ensure easy and safe operation.

Blocking the transition to assembling/disassembling mode during loading

"LMI automatically sets front-end att. erection mode with letter message."

In the range out of crane working area, the LMI display panel automatically indicates "Now, out of crane working range" with a rigging instruction, and it is available to lift front-end att. off ground without the influence of LMI safety functions, and, after front-end att. is lifted over the range of crane working area, LMI safety function gets back automatically for safe erection work.

Supporting the operation when the lifting load is not visible

"Lifting height indication function"

By equipping a lifting height indication function (drum counter function) as standard, operations can be facilitated even if the lifting load is not visible.

Reducing the shock resulting from the sudden stop

"Boom speed slowdown device"

The operation slowly terminates by sensing the shock caused by a sudden stop as a result of an automatic stop due to boom overhoisting or overloading. As the result of the shock reduction, the accident risk has been reduced.

Arbitrary control

Swift machine stoppage in emergencies
"Engine stop switch"



A large engine stop switch is allocated to the upper section of the cab rear side. It stops the machine immediately in emergencies reducing the risks resulting from accidents.

Detecting boom hoisting operation automatically
"Automatic drum pawl locking device"

By detecting boom hoisting operations, locking and unlocking are performed automatically protecting the machine from accidents due to malfunctioning.

Protecting the machine from accidents at entry/exit and when in an unattended state

"Lock lever" (fool proof shut-off system)

No entry/exit is allowed without raising the locking lever. By raising the locking lever, all operations will stop protecting against accidents during entry/exit and when the machine is in an unattended state.



* The image includes optional specifications.