

■ General dimensions

Units: mm

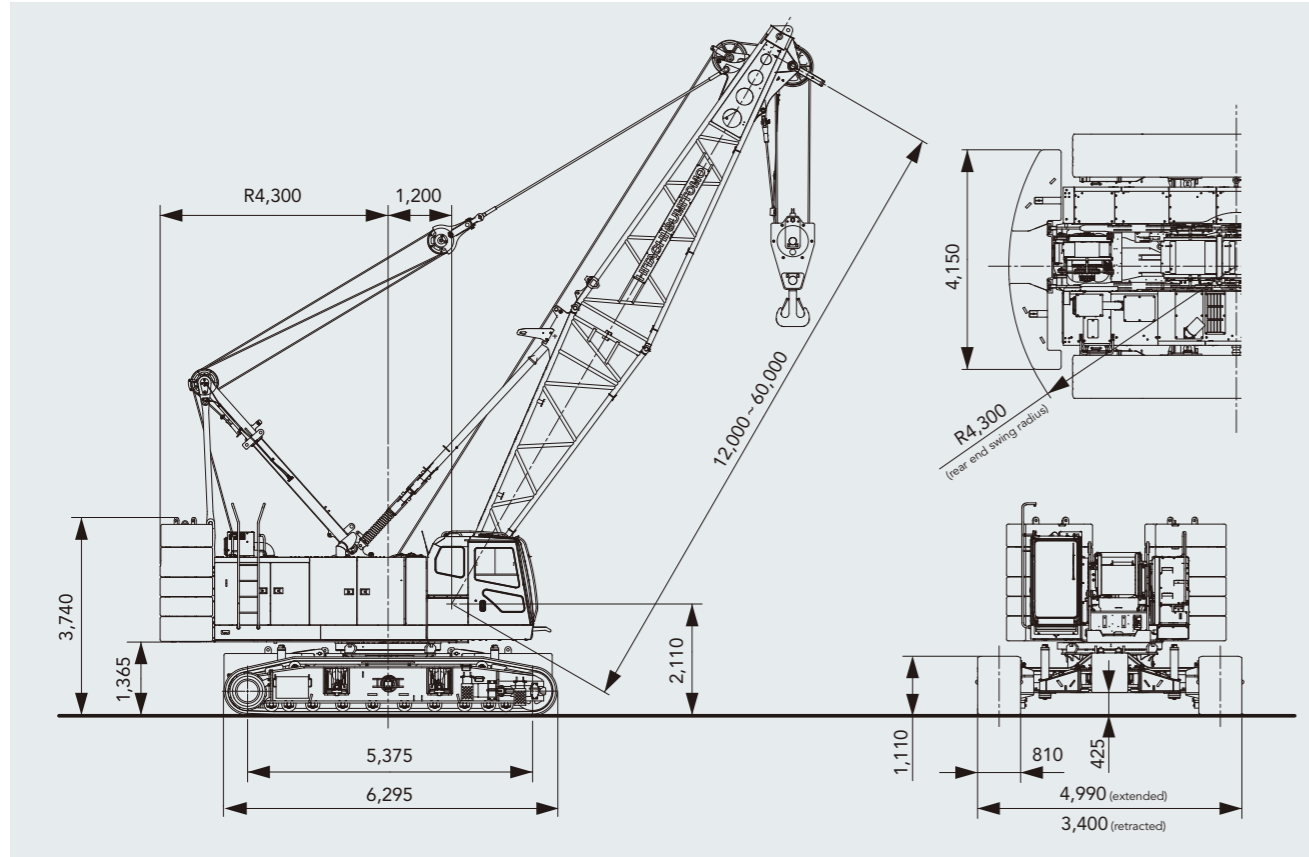

■ Specifications

Model		SCX1000A-3	
Application		Liftcrane	Clamshell
Max. lifting capacity	t × m	100 × 3.8	—
Basic boom length	m	12	12
Max. boom length	m	60	24
Crane jib length	m	10~28	—
Boom + crane jib length	m	51+28	—
Rope line speeds (*1)	Front/rear main drum (rated with 12 t load)	m / min	110(45)
	3 rd winch (rated with 12 t load)	m / min	95(30)
	Boom hoist drum	m / min	44
Swing speed	min ⁻¹ (rpm)	2.3	
Travel speed high/low (*2)	km/h	2.0/1.1	
Gradeability	% (°)	30(17)	
Bucket capacity	m ³	—	2.5
Allowable gross weight	t	—	10
Max. digging depth	m	—	36
Engine	Make & model	Isuzu 6HK1 (Stage III A / Tier 3)	
	Rated output	kW/min ⁻¹ (PS/rpm)	200.6/1,850(269/1,850)
Ground contact pressure	kPa(kgf/cm ²)	117(1.19)	116(1.18)
		w/basic boom, 100 t hook block	w/basic boom, 2.5 m ³ bucket
Operating weight	t	104	Approx. 103
		w/basic boom, 100 t hook block	w/basic boom, 2.5 m ³ bucket

Notes: 1. Rope line speeds vary under load and operating conditions (*1). 2. Travel speed is based on flat, level and firm supporting surface with no load and 12 m basic boom (*2).

- We are constantly improving our products and therefore reserve the right to change designs and specifications without notice.
- Units in this catalog are shown under International System of Units (SI). The figures in parenthesis are under the older British Gravitational System of Units.
- Illustrations may include optional equipment and accessories, and may not include all standard equipment.
- Standard equipment and accessories may vary by country and region.

Address inquires to :

**Hitachi Sumitomo Heavy Industries
Construction Crane Co., Ltd.**

9-3, Higashi-Ueno 6-chome, Taito-ku, Tokyo 110-0015, Japan
Phone: 81-3-3845-1387 Facsimile: 81-3-3845-1394
<http://www.hsc-crane.com>

**SCX
1000A-3**

A large crawler crane is the central focus, positioned on a construction site. The crane's lattice boom is extended upwards, and the words "HITACHI SUMITOMO" are visible on its side. The crane is white with blue accents. In the background, a concrete bridge structure is under construction, with several support pillars. The sky is a vibrant blue with scattered white clouds. The overall scene conveys a sense of industrial power and modern infrastructure development.

Power and productivity boosts confidence.

The goal was to make valuable contributions in various fields around the world. To achieve this, HSC created a whole new benchmark for crawler cranes. The result is powerful and smooth work capabilities, backed with advanced operations; highly-efficient transportation and assembly; eco-friendly with great fuel economy. And of course safety and reliability are paramount. Designed with peace of mind to boost confidence, the ideal crawler crane is now available. Behold the "SCX1000A-3" making its global mark for a new generation. This new benchmark is set to take the world, business, and even the future, to all new highs.

**SCX
1000A-3**



SCX1000A-3 PERFORMANCE

Smooth and powerful. Advanced work capabilities are set to revolutionize your work site.

Hitachi Sumitomo cranes are at the forefront of their field, and are designed to create ideal working conditions to suit any work site or requirements. The SCX1000A-3 has been added to the lineup with a 10 t greater lifting capacity over the SCX900-2, as well as a host of powerful work capabilities. This drastically improves the base performance of the crane to provide true peace of mind for any type of work. There is now no reason to compromise when it comes to workability.



- **Lifting performance**
(maximum load x work radius)
100 t x 3.8 m (crane specifications)
(SCX900-2 was 90 t x 4.0 m)
- **Maximum work radius**
1.7 t x 47.2 m (crane specifications)
(SCX900-2 was 1.5 t x 44.4 m)

Better lifting performance for excellent workability

The SCX1000A-3 features outstanding design characteristics, and is now more powerful and refined. Ample performance helps to increase the crane's work radius to bring unprecedented efficiency to your work site. The powerful winch not only makes lifting easier, but also provides superior strength when lowering loads, where precise control is essential. Smooth and accurate work gives rise to safety and peace of mind.

All-new powerful winch

The power of the new 12 t-rated line pull winch (rope ϕ 26 mm) has been increased by 8% to increase scope for lifting heavy loads with line-speed 45m/min, and provide better capability for simultaneous movements. Combined with a new brake* that offers better operating feel, the crane delivers simply outstanding workability.

A 13.5 t-rated line pull winch (rope ϕ 28 mm) is optionally available.

* Optional extra

3rd winch OPTION

The 3rd winch has a new multiple wet-disc type brake with a 12 t-rated line pull winch and large winding capacity 220 m long rope. This allows the entire casing driver to be hoisted.

Ordinary operation

ECO winch mode

Minimal fuel consumption and high-speed winching with light loads

Simple operation ECO winch mode is activated automatically using the ordinary control levers if the ECO winch switch is ON and certain operating conditions are met (hook only, 1150 rpm or lower engine speed).

Eco winch mode with high-speed winching and low-fuel consumption

Also included is a new Eco winch mode, which allows high line speeds under light loads without having to increase the engine speed (low rpm). This mode delivers outstanding workability in situations such as high-elevation construction sites and work requiring many wire replacements, and also limits fuel consumption and noise as engine speed can be kept at a minimum.

SCX1000A-3 CONTROL

High-precision, exactly as intended. A level of control available to all.

Flexible operation and performance makes the crane truly shine during heavy lifting or precision jobs. The crane has been designed so that it can be operated by anyone, exactly as they intend to, instead of relying on the operator's level of experience or skill. Outstanding usability has been the key behind development, and can be experienced at your work site, wherever in the world that may be.

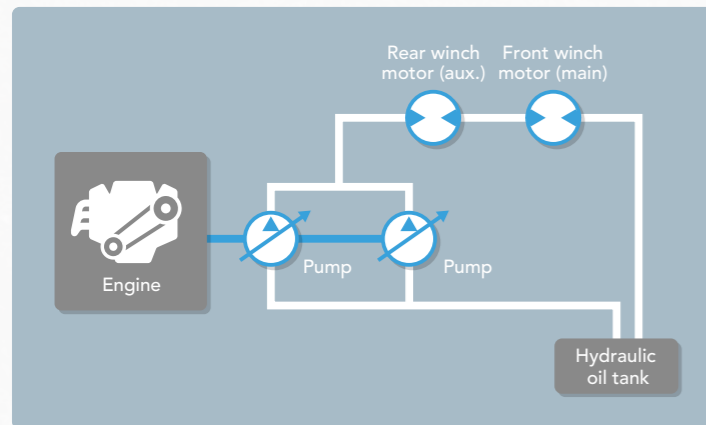

Combined hydraulic circuits

The hydraulic system uses HSC's own unique combined hydraulic circuit. By increasing and optimizing the pump pressure through the use of a mixed circuit to control the hydraulic oil from two hydraulic pumps, the sense of operability in travelling, hoisting/lowering, swing and boom hoisting can be enhanced. Even for multiplex operations, the latest hydraulic control system is able to support all tasks efficiently through priority control matching the needs. This helps to achieve a sense of operability that matches the intent of the operator.

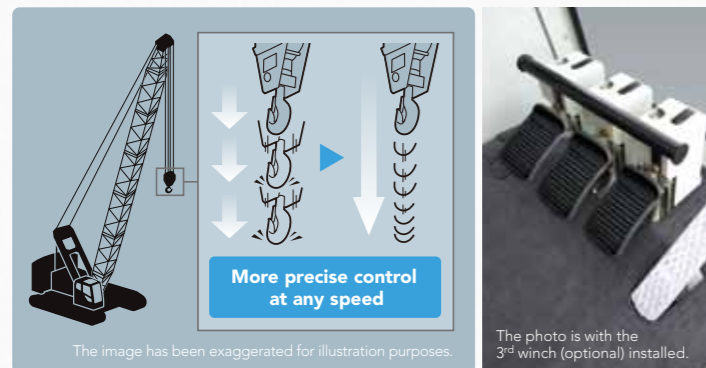

New multiple wet-disc type brake with improved control feel OPTION

The optional brake uses a new multiple wet-disc type that offers better control. A hanging brake pedal gives the operator smooth and precise response. Reliable braking performance is now a reality even under high loads, all while minimizing disc temperature. The system can even be used for heavy digging and foundation work that utilizes free-fall operation*.

*Free-fall function is an optional extra for models equipped with the 12 t rated line pull winch. See the Spec. catalog for more details.



Control dials

Fine speed control dials for operations such as hoisting, lowering, swinging and boom hoisting are positioned in a central location on the left side console. Operations can be adjusted at will to suit the particular job.

Swing neutral brake

Switches for swing free/swing brake when the control lever is in the neutral position have been installed. When the swing lever is in the neutral position, the operator may choose between free or brake depending on the work and personal preferences.



Swing brake operation pedal OPTION

A swing brake operation pedal has been employed to ensure precise swing control under strong-wind situations. This maintains a high level of control when swinging the cab around, even on the harshest of work sites.





SCX1000A-3 TRANSPORTABILITY

Speedy and smart. Exceptional transportability and assembly guarantees better results.

The crane represents exceptional value when transporting it between sites. Performance has been retained while offering a design that allows efficient transportation, assembly and disassembly. This level of transportation and assembly combine to drastically improve efficiency on any work site.

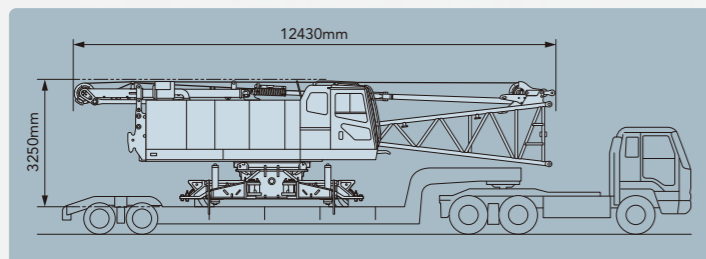

2.99 m transportation width, body weight with lower boom approximately 30 t

To comply with changes in transportation requirements and more stringent regulations, the crane can be loaded on less than 3 m-wide trailers. And in addition to a crane body width that is 2.99 m, the weight of the body with lower boom has been kept approximately 30 t, which drastically improves ease of assembly after the crane has been transported to a site. This also leads to a reduction in transportation costs.



Folding gantry with hoisting cylinder

The folded gantry and main frame can be connected together, allowing the crane to be raised with the gantry in its lowest state. A hoisting cylinder has been installed as standard on the gantry itself, for quicker disassembly and assembly work.



New counter weight

A lower weight and new counter weight split into six separate pieces has been used to help reduce body weight but improve lifting performance. The lighter weight of each counter weight makes assembly easier.



Retract device

A retract device has been included as standard to change the width of the crawlers, making transportation of the crawler tracks easier. The retract pin can be pulled out from the outer side of the crane, which helps to improve safety during work.

Simple assembly crawler side frame

Comes with a folding extension beam and special link for lifting. These make the crawler side frame easier to assemble and disassemble, and improve safety.

Designed for ease of transportation and assembly

- [Transportation]
 - Lugs for boom lifting
- [Assembly]
 - Multi-assembly stage monitoring system
 - Lugs for lifting crawler side frame
 - Folding gantry with hoisting cylinder
 - Hydraulic shoe tension unit OPTION

Reduction counter weight specification OPTION

Reduction counter weight specification are available as an optional extra to provide added flexibility for a diverse range of worksites, including high locations and within tight internal areas where operating weight is limited or restricted (with counter weight detector).

Counter weight (piece)				
Lower weight	Yes	Yes	No	No
Total operating weight	104 t	98 t	77 t	70 t

SCX1000A-3 SAFETY

Reliable and precise lifting with advanced safety features

Improving safety should come first and foremost. A simple, easy-to-view interface has been designed to ensure that information is provided to the operator in the most reliable way possible. Various accident prevention measures and multiple redundant safety devices have also been included to provide comfort for the operator. Rest assured that your work is safe, backed with a full complement of advanced safety equipment.

Moment limiter display

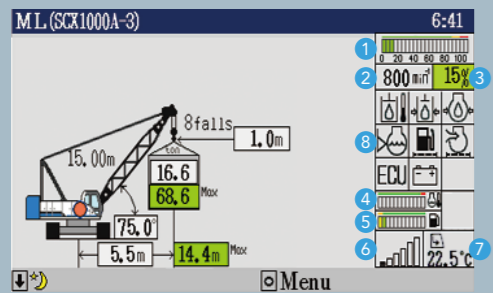

- 1 Load ratio indicator (%)
- 2 Engine speed
- 3 Load ratio (%)
- 4 Water temperature (engine coolant)
- 5 Fuel gauge
- 6 Blower condition
- 7 Air-conditioner setting state
- 8 Warning icons

Moment limiter with large screen display

A large screen display has been used offering excellent visibility and field of view of any job. A host of items can be shown, while a simple display layout ensures that information is provided to the operator properly. The display has also been designed with an interactive interface to follow any movement of the crane from a safety perspective, which helps to limit unintended operations and maintain utmost safety.

ML Anti-two block

A new anti-two block using a lifting height indication device is offered as a standard equipment. When a height restriction is set in advance in the lifting height meter, the slowdown function will kick in as the restricted height is approached to prevent hook overhoist. Together with the anti-two block switch, the lifting height moment limiter provides a redundant level of safety against hook overhoist, leading to improved safety.

Note) This function plays a supplementary role to the existing moment limiter and use of this equipment alone is prohibited by laws and regulations.

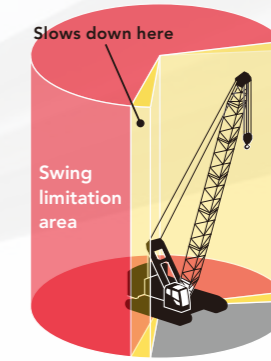

Swing restriction unit OPTION

This device prevents the crane from swinging into objects and causing damage, by notifying the operator of the swinging range and automatically stopping the crane when required. The result is an added level of safety when working in tight areas.



Drum and rear view monitor system OPTION

Four monitoring cameras have been installed to make it easier to oversee the condition of the front /rear drum, boom hoist drum, back and left-rear. For added safety, checks of each stage of operation are also easier as the wide screen is connected to switchable cameras.

Designed for safe work

An auto drum lock is installed as standard, which detects boom hoisting operations and automatically applies the lock when the lever is in the neutral position. Various warning alarms and information are conveyed to the operator to help reduce the number of careless accidents. The width of the skywalk (optional extra) has been increased to make assembly easier. All these combine to ensure work is conducted as safely as possible.



Wider skywalk (made by FRP) OPTION



Folding type upper house handrails OPTION

Other safety functions and devices

- Winch drum lock (front, rear)
- Individual winch operation lever locks
- Three color percentage indicator OPTION
- Auto drum lock (boom hoist)
- Anti-two block
- Gate lock lever
- Firewall
- Emergency engine stop switch

Enhanced visibility and functionality with greater comfort

To provide operators with greater comfort over a longer work span, HSC has designed the crane to be easy to use from the ground up. Design elements such as excellent visibility and an optimum working position help to reduce operator fatigue, while at the same time increasing comfort and functionality to ensure maximum performance, day-in, day-out.



Major improvements to operating field of view

The cab has extra-wide windows to improve visibility in all directions. Green tinted safety glass has been used all round to protect the operator from UV rays and objects that may have come free during operation. A new wiper provides a greater area of visibility when working in rain.



Comfortable and highly-functional seat for the ideal work position

The new seats are designed with the ideal shape for a more comfortable seating position. The wide range of seat adjustments means it suits any body shape, for the best work and a relaxing posture. Seat with suspension is available as an option.



New large sliding door

A sliding door and wide platform have been implemented to reduce the amount of space required when opening and closing the door, which makes getting in and out of the cab a breeze. Three steps on the side of the crawler side frame have been used for even better access.



Optimized lever and switch layout

The pitch of the armchair levers can be optimized to improve operation with an intelligent and ergonomic switch layout.



Cross operation lever OPTION

Cross operation lever is provided for a good, easy and comfortable operation for two main operating drums, boom hoist drum and swinging. For travel motion, two armchair levers are provided behind right-hand cross operation lever for operator comfort.

Clean and economical. Environmentally-friendly for mankind and society.

A new greener engine delivers clean power required for HSC's new generation of cranes. This advanced, environmentally-friendly technology ensures a more pleasant experience for everyone, surrounding towns, well into the future. Fuel consumption has been fine-tuned for more economic operation, which also presents major benefits from a management perspective.



For SCX-3 model, Stage III A (Tier 3) engine machine is also available in less regulated area. New engine emission gas (Stage III B, Tier 4 i) is regulated in Japan, USA and Europe and Stage III B (Tier 4 i) Engine requires high grade fuel, engine oil and without aftertreatment module.

Powered with a clean engine

Powered with an environmentally-friendly engine that is equivalent to EU stage III A and US Tier 3 emission regulations. A major reduction in exhaust gas emissions and a reduction in fuel consumption help to decrease CO2 emissions. The new engine and power train have been engineered to be even more environmentally-friendly.

■ Clean performance (EU)

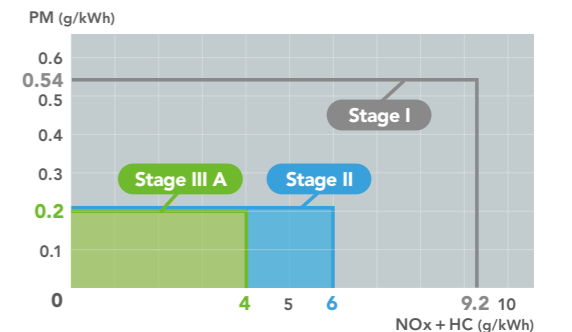

Technologies to improve fuel efficiency

In addition to improvements to the engine combustion efficiency, paired with enhanced hydraulic controls, idle stop functions and Eco winch mode have also been used to comply with more stringent exhaust gas regulations as well as improve fuel economy.

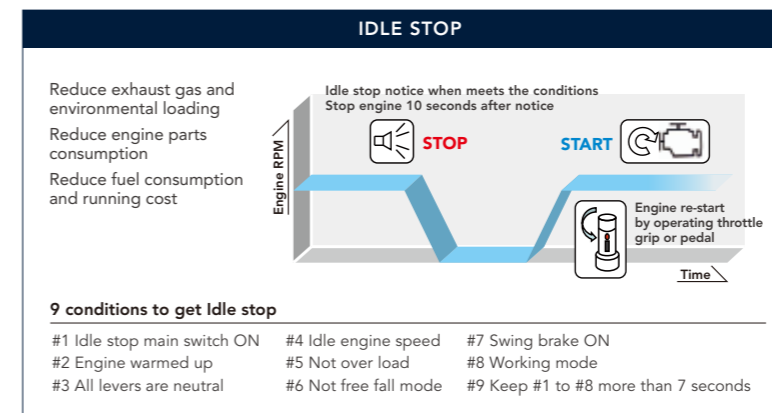

Counter weights with outstanding recyclability

Environmentally-friendly design with counter weights made from cast weights that can easily be recycled.



Utmost reliability on work sites. Today, and decades into the future.



There are numerous ways to measure quality. Reliability that ensures peace of mind during daily operations is just one. HSC has designed the SCX1000A-3 from early on in the development stage to deliver enhanced durability and ease of maintenance. Engineered with a safe design for improving operating capabilities and reducing running costs, HSC cranes have evolved to deliver more benefits than ever before.



High-durability box type track shoes



New boom angle sensor



Shoe automatic tension unit OPTION



New load cell

Measures for improving durability

Increasing the strength of each part essential for operations is the first step. Reliability has also been fine-tuned to maximize work capabilities. Only the most stringent quality standards have been employed by HSC, from the start of development to production, all the way through to durability testing. Every aspect has been honed to ensure reliability, including a stronger lower frame, and greater precision load cells and boom angle sensor. HSC has developed a truly environmentally-friendly crane for all, built on strict eco-management standards.



Even easier maintenance

A central layout has been used for inspection equipment, combined with more gauge ports and a host of other useful functions. Maintenance has been made so much easier with improvements to engine servicing, and a layout that makes each filter and fan belt a breeze to replace.